

*Scientific Reports*

---

**- Transcriptomic dissection of sexual differences in *Bemisia tabaci*, an invasive agricultural pest worldwide**

Wen Xie<sup>a1&</sup>, Litao Guo<sup>b1&</sup>, Xiaoguo Jiao<sup>c3</sup>, Nina Yang<sup>d1</sup>, Xin Yang<sup>e1</sup>, Qingjun Wu<sup>f1</sup>, Shaoli Wang<sup>g1</sup>, Xuguo Zhou<sup>h2\*</sup>, Youjun Zhang<sup>i1\*</sup>

<sup>1</sup>*Department of Plant Protection, Institute of Vegetables and Flowers, Chinese Academy of Agricultural Sciences, Beijing, 100081, P. R. China*

<sup>2</sup>*Department of Entomology, University of Kentucky, Lexington, KY 40546-0091, USA*

<sup>3</sup>*Hubei University, Wuhan, 430062, P. R. China*

& These authors contributed to this work equally

Email correspondence: <sup>a</sup>xiewen@caas.cn, <sup>b</sup>glt0629@163.com, <sup>c</sup>jiaoxg@hubu.edu.cn, <sup>d</sup>nina809@163.com, <sup>e</sup>hljdxyx@163.com, <sup>f</sup>wuqingjun@caas.cn, <sup>g</sup>wangshaoli@caas.cn, <sup>h</sup>xuguo Zhou@uky.edu, <sup>i</sup>zhangyoujun@caas.cn

---

\* Corresponding Authors:

Dr. Youjun Zhang

Department of Entomology, Institute of Vegetables and Flowers

Chinese Academy of Agricultural Sciences

12 Zhongguancun Nandajie, Haidian District

Beijing 100081, China

Phone: 86-10-82109518

Fax: 86-10-82109518

Email: zhangyj@mail.caas.net.cn

Dr. Xuguo "Joe" Zhou

Department of Entomology

University of Kentucky

S-225 Agricultural Science Center North

Lexington, KY 40546-0091

Phone: 859-257-3125

Fax: 859-323-1120

Email: xuguo Zhou@uky.edu

---

## SUPPORTING INFORMATION

### FIGURES

**Figure S1** The enriched KEGG pathway analysis for female-biased genes relative to male.

**Figure S2** The enriched KEGG pathway analysis for male-biased genes relative to female.

**Figure S3** The enriched GO analysis for female and male biased genes. **A.** Female enriched Go terms. **B.** Male enriched Go terms.

**Figure S4** Sequencing strategy.

### TABLES

**Table S1** Annotation of female-biased genes.

**Table S2** Annotation of male-biased genes.

**Table S3** Summary of reciprocal best matched sequences (RBMs).

**Table S4** Summary of the differentially expressed genes between sexes.

**Table S5** Primers used for the qRT-PCR analyses.

**Table S6** qRT-PCR validation and comparative analyses with RNAseq data.

**Fig. S1. The enriched KEGG pathway analysis for female-biased genes relative to male.**

**A.** Pyrimidine metabolism, **B.** Ribosome, **C.** mRNA surveillance pathway, **D.** Ribosome biogenesis in eukaryotes, **E.** RNA polymerase, **F.** RNA degradation. **G.** DNA replication. **H.** RNA transport.

KEGG pathway mapping (used *Acyrtosiphon pisum* as KEGG organisms) and further KEGG enrichment analysis using local server KOBAS 2.0, Q-value < 0.05 is chosen as enriched pathway. The red box denotes the female marker gene that could be annotated into a *Acyrtosiphon pisum* KEGG network.

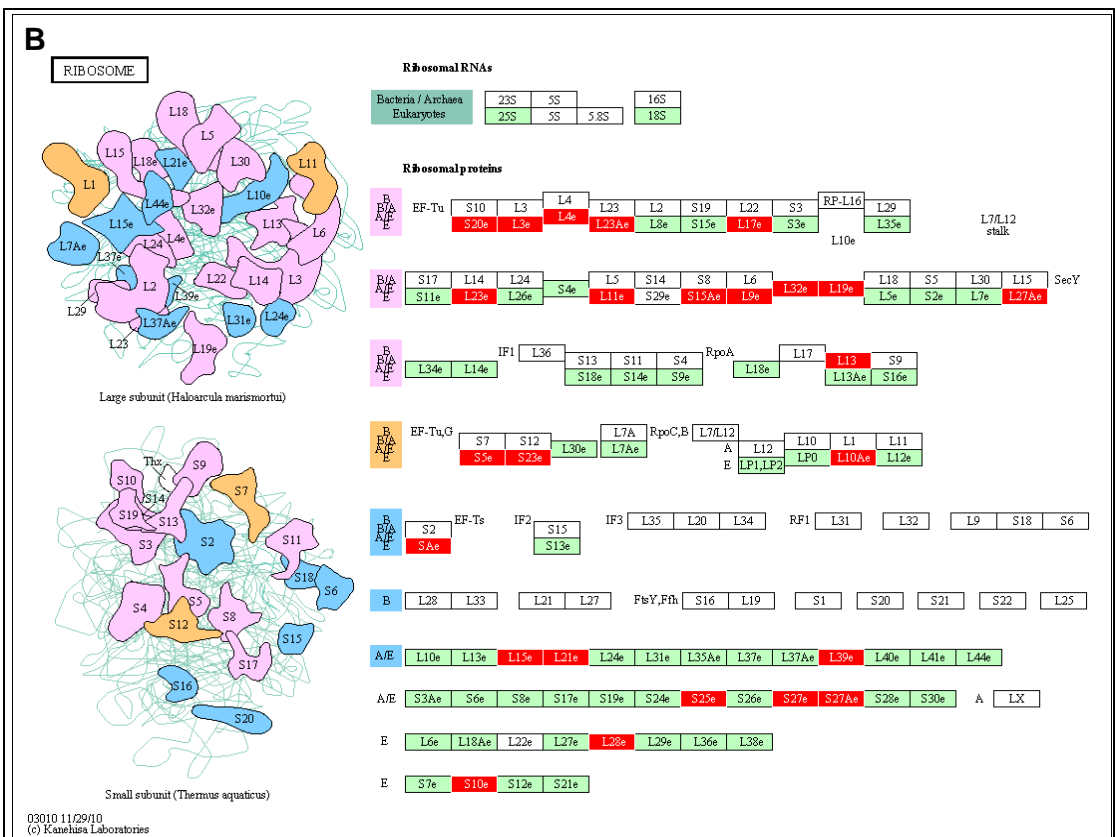
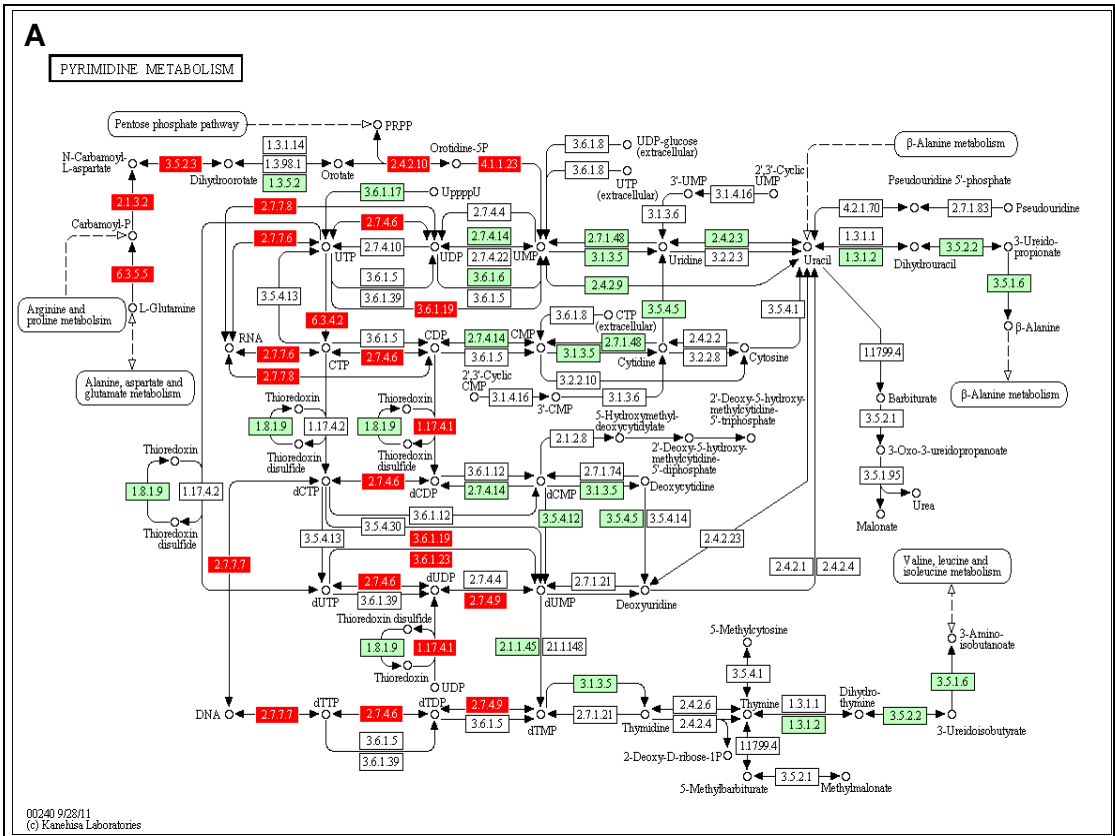

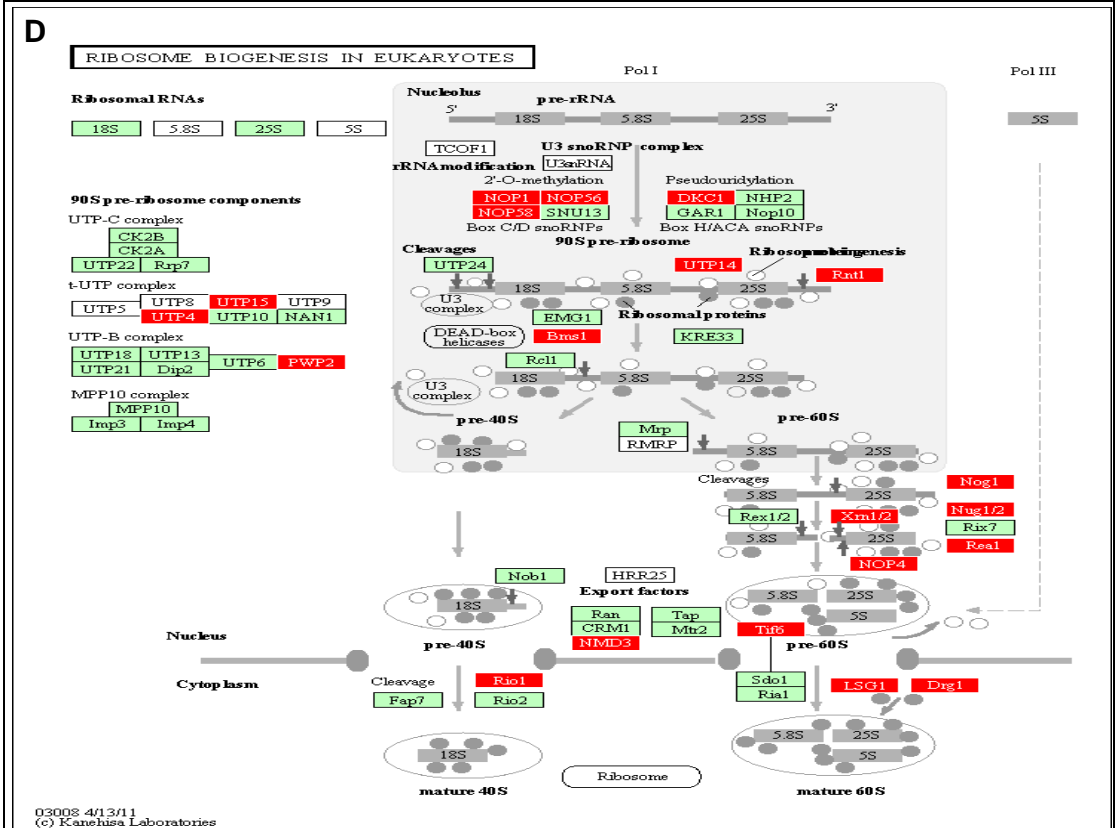
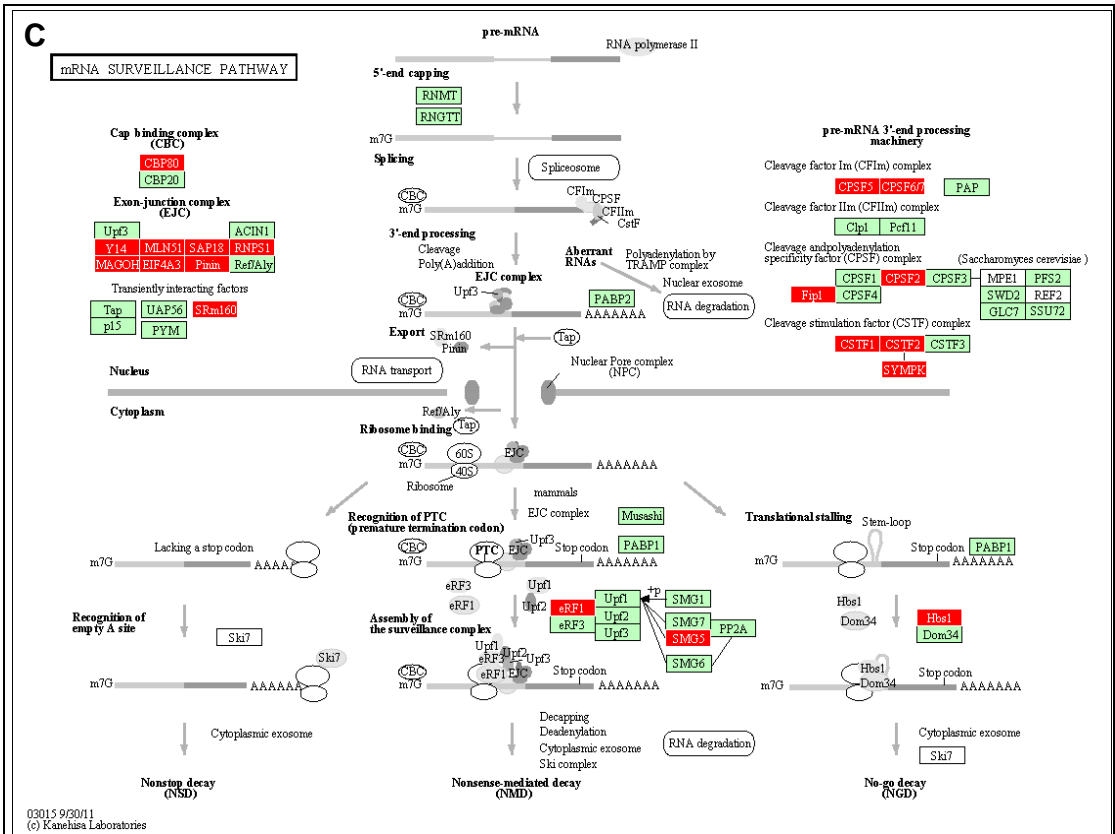

**E**

**RNA POLYMERASE**

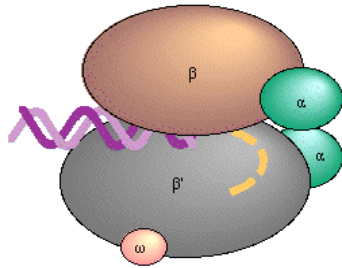

RNA polymerase (*Thermus aquaticus*)

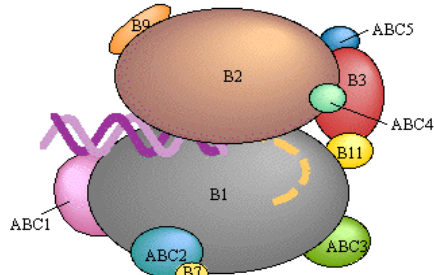

RNA polymerase II (*Saccharomyces cerevisiae*)

Bacterial

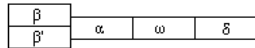

Archaeal

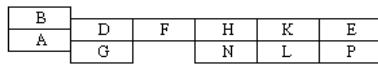

Eukaryotic Pol II

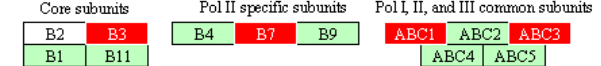

Eukaryotic Pol III

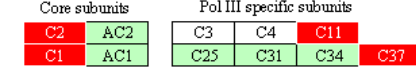

Eukaryotic Pol I

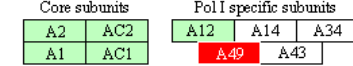

03020 3/25/11  
(c) Kanehisa Laboratories

**F**

**RNA DEGRADATION**

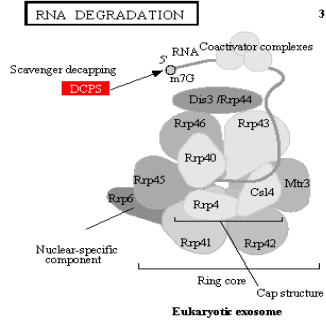

Eukaryotic exosome

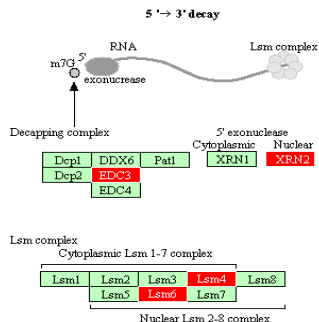
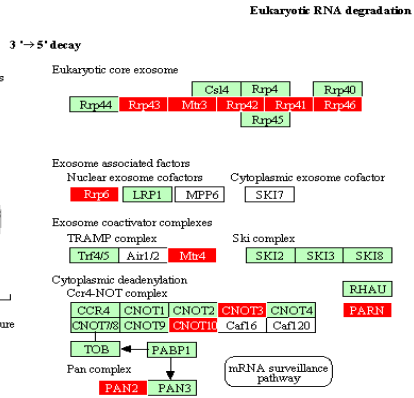

**Bacterial RNA degradation**

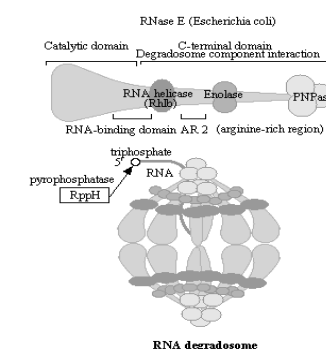

RNA degradosome

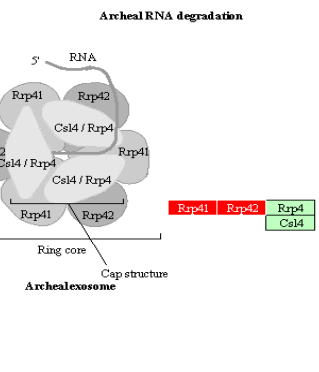

Archaeal exosome

03018 1/24/11  
(c) Kanehisa Laboratories

**G**

**DNA REPLICATION**

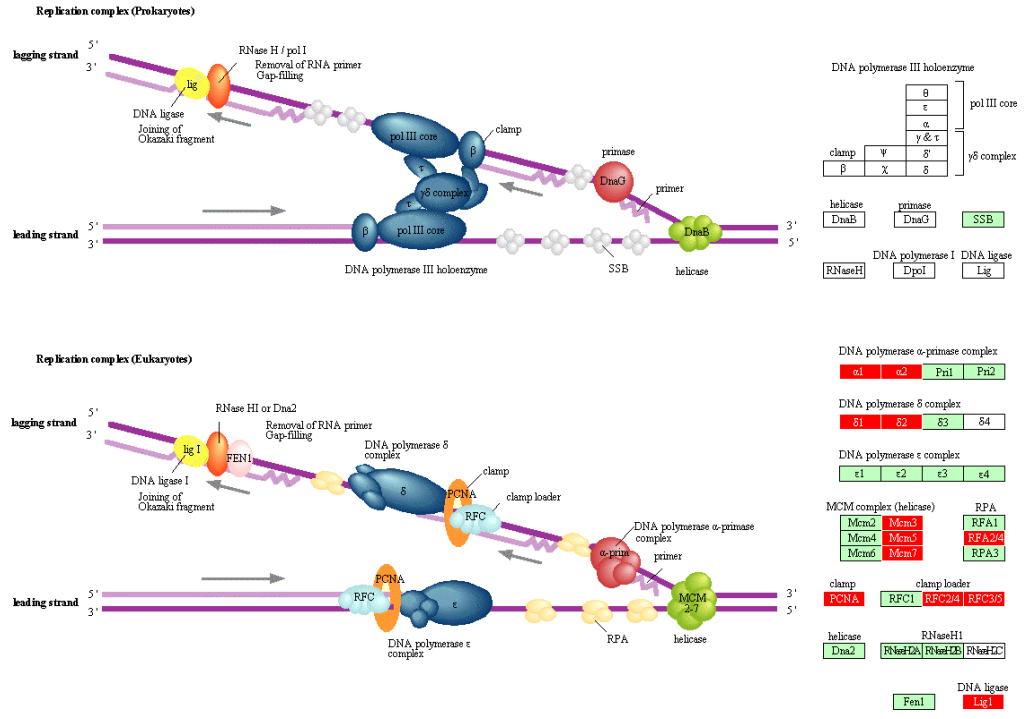

03030 10/20/10  
(c) Kanehisa Laboratories

**H**

**RNA TRANSPORT**

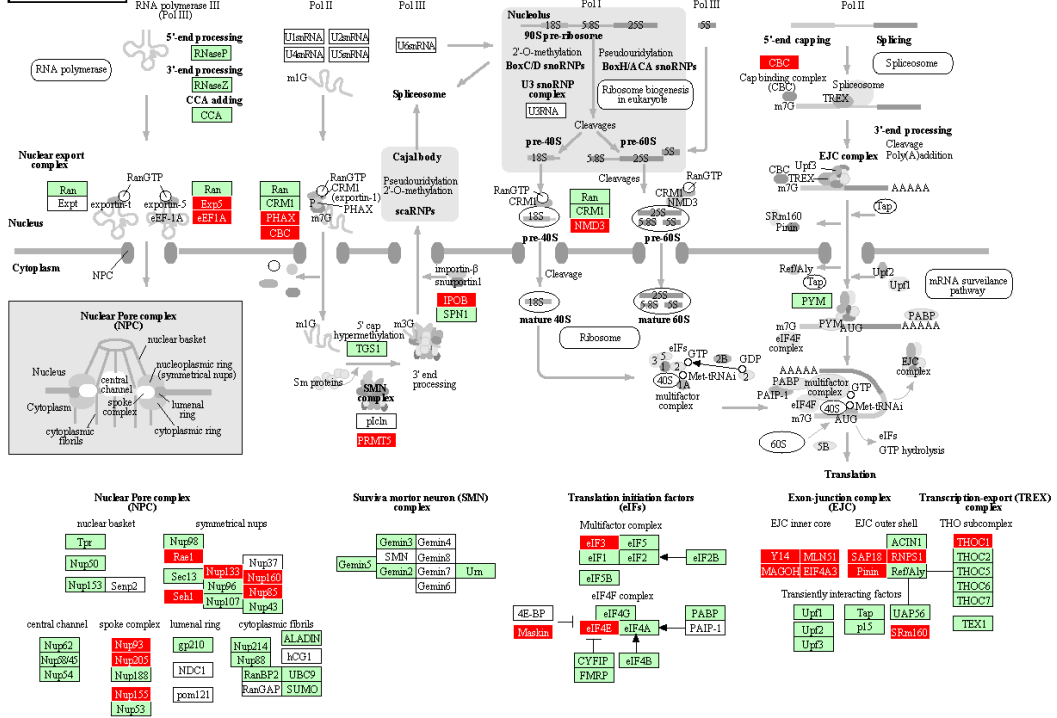

03013 9/21/11  
(c) Kanehisa Laboratories

**Fig. S2. The enriched KEGG pathway analysis for male-biased genes relative to female.**

**A.** Phototransduction - fly, **B.** Lysosome, **C.** Nitrogen metabolism, **D.** Glycerophospholipid metabolism, **E.** Phagosome.

KEGG pathway mapping (used *Acyrtosiphon pisum* as KEGG organisms) and further KEGG enrichment analysis using local server KOBAS 2.0, Q-value < 0.05 is chosen as enriched pathway. The red box denotes the male marker gene that could be annotated into a *Acyrtosiphon pisum* KEGG network.



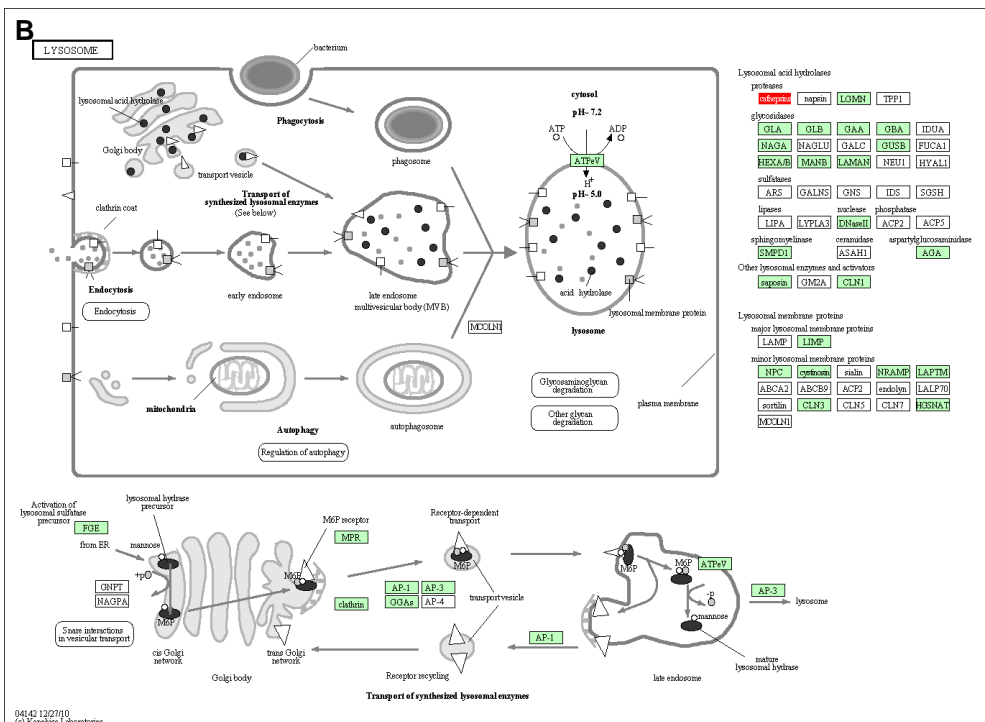
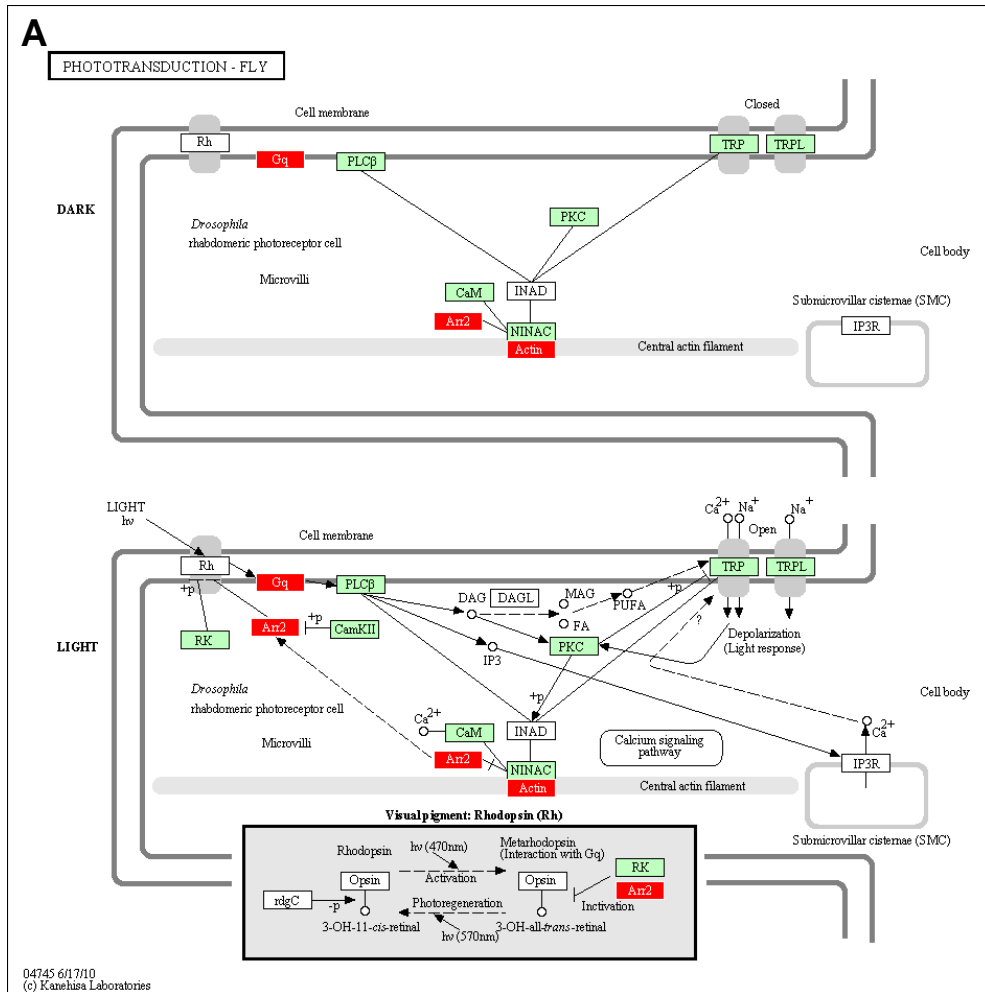

C

NITROGEN METABOLISM: REDUCTION AND FIXATION

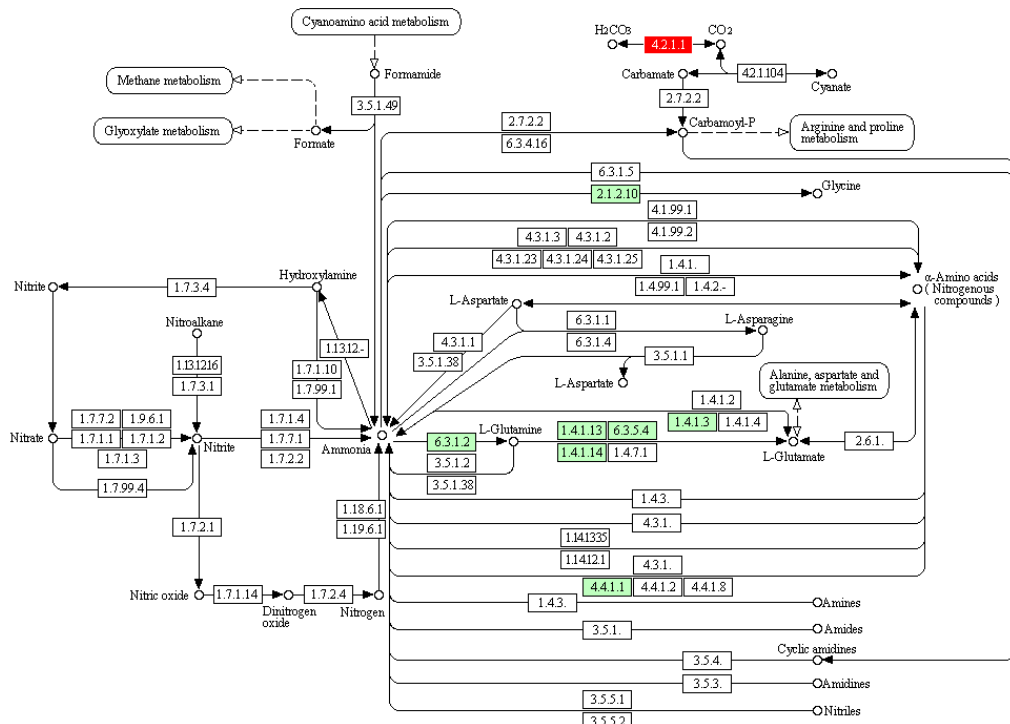

00910 9/28/11  
(c) Kanehisa Laboratories

D

GLYCEROPHOSPHOLIPID METABOLISM

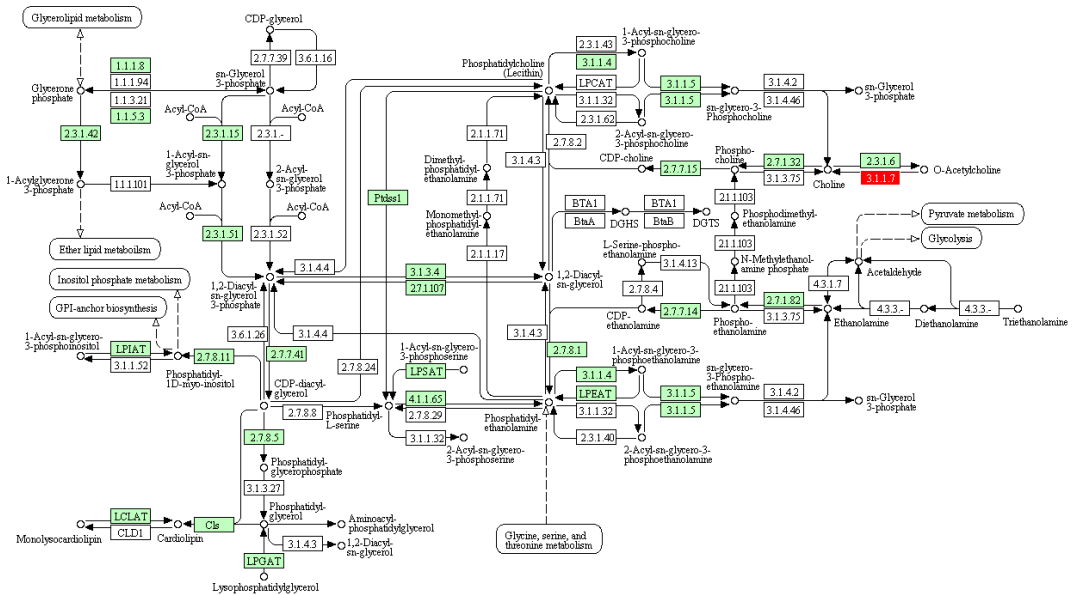

00564 12/6/11  
(c) Kanehisa Laboratories

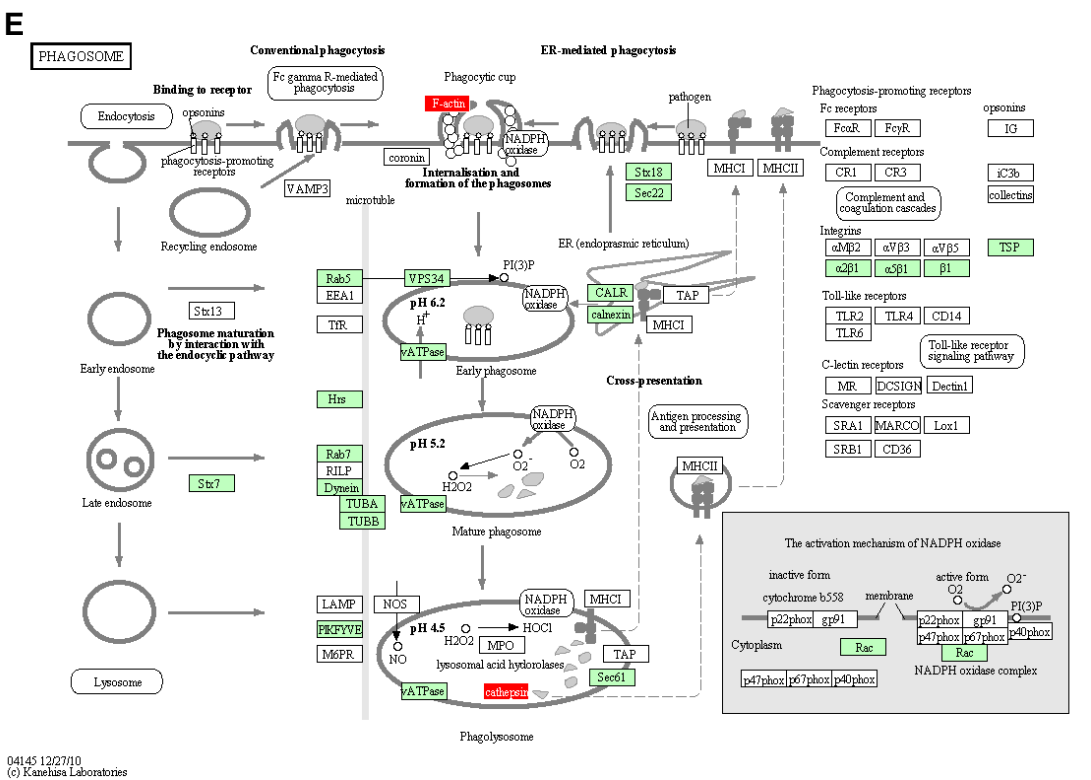

**Fig. S3. The enriched GO analysis for female and male biased genes. A. Female enriched Go terms. B. Male enriched Go terms.** GOSeq explicitly takes into account gene selection bias due to difference in gene lengths and thus numbers of overlapping sequencing reads. GOSeq is used for GO enrichment analysis, Q-value, 0.05 is chosen significant cutoff.

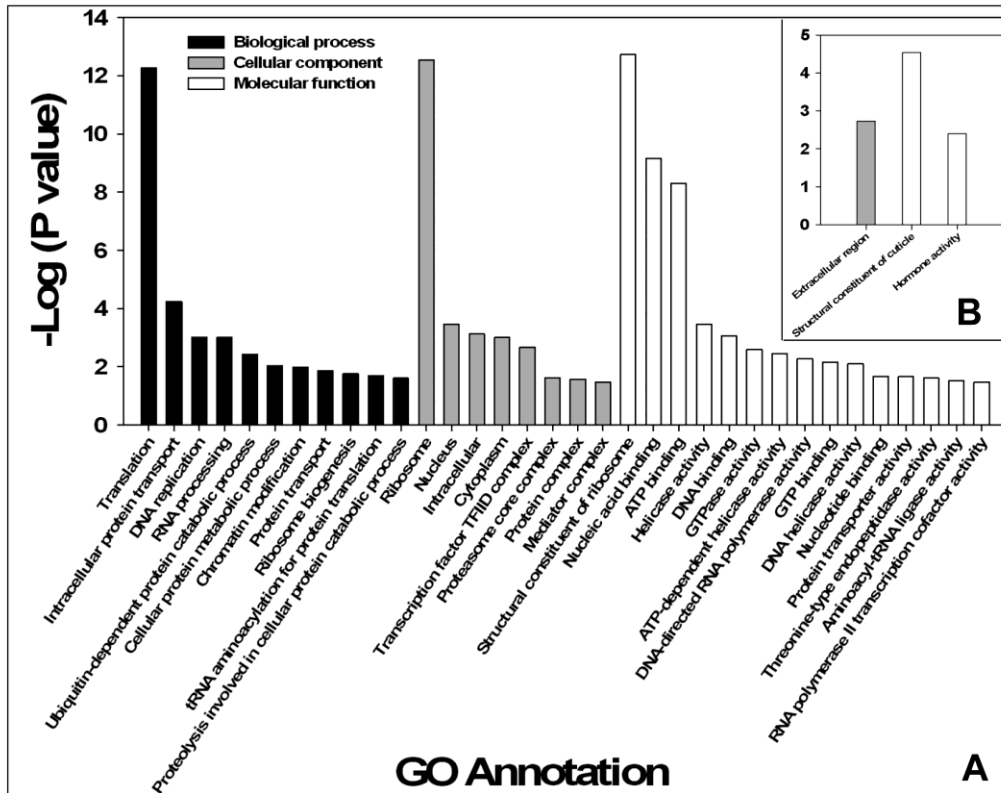

**Fig. S4.** Sequencing strategy.

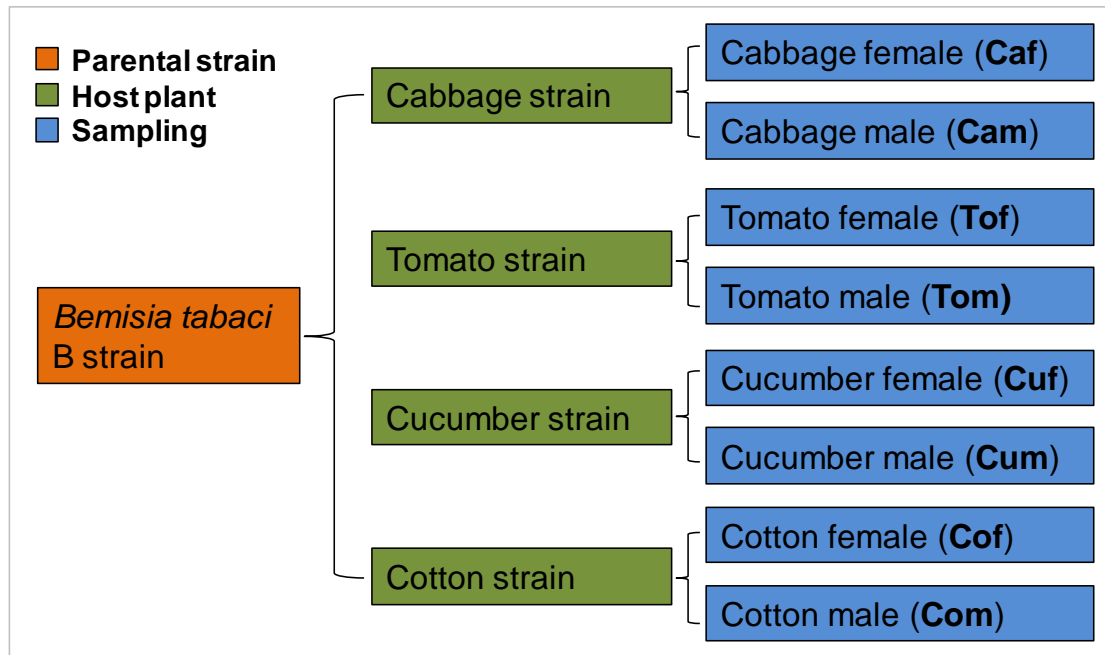

**Table S1 Annotation of female-biased genes**

<b>Assembly ID</b>	<b>NR database</b>
comp5946_c0_seq2	PREDICTED: hypothetical protein LOC409606 [Apis mellifera]
comp5566_c0_seq1	hypothetical protein SINV_80284 [Solenopsis invicta]
comp12946_c0_seq1	PREDICTED: hypothetical protein LOC100164170 [Acyrtosiphon pisum]
comp5546_c0_seq1	PREDICTED: ATP-dependent helicase brm-like [Acyrtosiphon pisum]
comp6965_c0_seq1	PREDICTED: f-box/LRR-repeat protein 2-like isoform 2 [Apis mellifera]
comp4175_c0_seq1	hypothetical protein BRAFLDRAFT_264350 [Branchiostoma floridae] gi 229290244 gb EEN60925.1  hypothetical protein BRAFLDRAFT_264350 [Branchiostoma floridae]
comp5860_c0_seq1	hypothetical protein TcasGA2_TC010807 [Tribolium castaneum]
comp8187_c0_seq4	PREDICTED: e3 ubiquitin-protein ligase Rnf220-like [Apis mellifera]
comp3052_c0_seq1	PREDICTED: exocyst complex component 5-like [Apis mellifera]
comp4761_c0_seq1	PREDICTED: histone-arginine methyltransferase CARMER-like [Bombus terrestris]
comp1364_c0_seq1	Sec61 alpha 1 subunit [Acyrtosiphon pisum] gi 52630957 gb AAU84942.1  probable transport protein Sec61 alpha subunit [Toxoptera citricida] &gt;gi 89574501 gb ABD76381.1  putative transport protein Sec61 alpha subunit [Acyrtosiphon pisum]
comp4895_c0_seq1	conserved hypothetical protein [Pediculus humanus corporis] gi 212515574 gb EEB17698.1  conserved hypothetical protein [Pediculus humanus corporis]
comp7230_c0_seq2	hypothetical protein BRAFLDRAFT_114978 [Branchiostoma floridae] gi 229294780 gb EEN65434.1  hypothetical protein BRAFLDRAFT_114978 [Branchiostoma floridae]
comp9683_c0_seq1	PREDICTED: MAGUK p55 subfamily member 6-like isoform 2 [Acyrtosiphon pisum]
comp4715_c0_seq1	PREDICTED: e3 ubiquitin-protein ligase TTC3-like [Xenopus (Silurana) tropicalis]
comp1319_c0_seq1	
comp4096_c0_seq1	PREDICTED: ATP-dependent RNA helicase Ddx1-like isoform 1 [Bombus terrestris]
comp8418_c0_seq1	hypothetical protein SINV_05940 [Solenopsis invicta]
comp1711_c0_seq1	GH19071 [Drosophila grimshawi] gi 193894137 gb EDV93003.1  GH19071 [Drosophila grimshawi]
comp13751_c0_seq1	hypothetical protein SINV_09205 [Solenopsis invicta]
comp3946_c0_seq1	hypothetical protein SINV_10218 [Solenopsis invicta]
comp8186_c0_seq1	PREDICTED: similar to dehydrololichyl diphosphate synthase [Tribolium castaneum] gi 270012136 gb EFA08584.1  hypothetical protein TcasGA2_TC006239 [Tribolium castaneum]
comp4677_c0_seq1	hypothetical protein DAPPUDRAFT_194601 [Daphnia pulex]

comp11291\_c0\_seq1 PREDICTED: condensin-2 complex subunit D3-like [Bombus terrestris]

comp2918\_c0\_seq1 PREDICTED: high affinity copper uptake protein 1-like isoform 1 [Bombus terrestris] gi|340711491|ref|XP\_003394309.1| PREDICTED: high affinity copper uptake protein 1-like isoform 2 [Bombus terrestris]

comp4553\_c0\_seq1 Sperm-associated antigen, putative [Pediculus humanus corporis] gi|212508991|gb|EEB12505.1| Sperm-associated antigen, putative [Pediculus humanus corporis]

comp5379\_c0\_seq1 hypothetical protein TcasGA2\_TC004440 [Tribolium castaneum]

comp2855\_c1\_seq1 PREDICTED: sister chromatid cohesion protein PDS5 homolog B-A-like [Apis mellifera]

comp4814\_c0\_seq1 SWI/SNF-related matrix-associated actin-dependent regulator chromatin subfamily E member 1 [Acromyrmex echinatio]

comp5474\_c0\_seq1 PREDICTED: DNA-directed RNA polymerases I, II, and III subunit RPABC1-like [Apis mellifera] gi|340724888|ref|XP\_003400810.1| PREDICTED: DNA-directed RNA polymerases I, II, and III subunit RPABC1-like [Bombus terrestris]

comp779\_c0\_seq1

comp414\_c0\_seq1

comp245\_c0\_seq1 putative peptidyl-prolyl cis-trans isomerase [Maconellicoccus hirsutus]

comp4452\_c0\_seq1 PREDICTED: similar to ubiquitin specific peptidase 14 [Tribolium castaneum] gi|270009745|gb|EFA06193.1| hypothetical protein TcasGA2\_TC009042 [Tribolium castaneum]

comp146\_c0\_seq1 PREDICTED: 60S ribosomal protein L4-like [Bombus terrestris]

comp10171\_c0\_seq1 serine palmitoyltransferase, putative [Pediculus humanus corporis] gi|212510255|gb|EEB13466.1| serine palmitoyltransferase, putative [Pediculus humanus corporis]

comp4872\_c0\_seq1 PREDICTED: kinesin-like protein KIF23-like [Bombus terrestris]

comp9464\_c0\_seq1 farnesoic acid methyltransferase [Schistocerca gregaria]

comp1828\_c0\_seq1 PREDICTED: hypothetical protein LOC100639010 [Amphimedon queenslandica]

comp6906\_c0\_seq1 PREDICTED: hypothetical protein [Strongylocentrotus purpuratus] gi|115925716|ref|XP\_001197429.1| PREDICTED: hypothetical protein [Strongylocentrotus purpuratus]

comp4945\_c0\_seq1

comp4290\_c0\_seq1 hypothetical protein TcasGA2\_TC000046 [Tribolium castaneum]

comp1339\_c0\_seq1 Deoxyuridine 5'-triphosphate nucleotidohydrolase [Camponotus floridanus]

comp2717\_c0\_seq1 PREDICTED: collagen alpha-1(IV) chain-like [Acyrtosiphon pisum]

comp328\_c0\_seq1

comp8322\_c0\_seq1 EH domain-binding protein 1 [Acromyrmex echinatio]

comp2967\_c0\_seq1 PREDICTED: aspartyl-tRNA synthetase, cytoplasmic [Apis mellifera]

comp4287\_c0\_seq1 PREDICTED: hypothetical protein LOC100161450 [Acyrtosiphon pisum]

comp8000\_c0\_seq1 hypothetical protein AND\_06034 [Anopheles darlingi]

comp2123\_c0\_seq1 Splicing factor 3B subunit, putative [Pediculus humanus corporis] gi|212510525|gb|EEB13688.1| Splicing factor 3B subunit, putative [Pediculus humanus corporis]

comp4596\_c0\_seq3 PREDICTED: similar to AGAP006448-PB [Tribolium castaneum] gi|270003022|gb|EEZ99469.1| hypothetical protein TcasGA2\_TC000040 [Tribolium castaneum]

comp1389\_c0\_seq1 T-complex protein 1 subunit alpha [Culex quinquefasciatus] gi|167878016|gb|EDS41399.1| T-complex protein 1 subunit alpha [Culex quinquefasciatus]

comp3129\_c0\_seq1 PREDICTED: malignant T cell-amplified sequence 1-like [Apis mellifera]

comp4630\_c0\_seq1 PREDICTED: DENN domain-containing protein 2A-like [Acyrtosiphon pisum]

comp276\_c0\_seq1

comp6076\_c0\_seq1 AGAP008908-PA [Anopheles gambiae str. PEST] gi|55235211|gb|EAA14867.2| AGAP008908-PA [Anopheles gambiae str. PEST]

comp251\_c0\_seq1 putative ribosomal protein S25 [Diaphorina citri]

comp7903\_c0\_seq9 PREDICTED: methylosome subunit pICln-like [Bombus terrestris]

comp3651\_c0\_seq1 PREDICTED: UDP-glucose:glycoprotein glucosyltransferase-like [Acyrtosiphon pisum]

comp4383\_c0\_seq1 PREDICTED: ATP-binding cassette sub-family G member 8-like isoform 1 [Acyrtosiphon pisum] gi|328718493|ref|XP\_003246499.1| PREDICTED: ATP-binding cassette sub-family G member 8-like isoform 2 [Acyrtosiphon pisum]

comp1858\_c0\_seq1 ABC membrane transporter [Athalia rosae]

comp6943\_c0\_seq1 PREDICTED: LOW QUALITY PROTEIN: gamma-tubulin complex component 3-like [Meleagris gallopavo]

comp5047\_c0\_seq1 PREDICTED: similar to CG11337 CG11337-PA [Tribolium castaneum] gi|270009999|gb|EFA06447.1| hypothetical protein TcasGA2\_TC009329 [Tribolium castaneum]

comp9138\_c0\_seq1 PREDICTED: cleavage stimulation factor subunit 1-like isoform 1 [Bombus terrestris]

comp3883\_c0\_seq1 PREDICTED: rac GTPase-activating protein 1-like [Apis mellifera]

comp4140\_c0\_seq1 PREDICTED: ribonuclease 3-like [Bombus terrestris]

comp8427\_c0\_seq1 PREDICTED: PAB-dependent poly(A)-specific ribonuclease subunit 2-like [Acyrtosiphon pisum]

comp6518\_c0\_seq1 PREDICTED: mitotic checkpoint protein BUB3-like [Acyrtosiphon pisum]

comp2701\_c0\_seq1 PREDICTED: LOW QUALITY PROTEIN: coiled-coil domain-containing protein 39-like [Bombus terrestris]

comp7198\_c0\_seq1 PREDICTED: DNA polymerase alpha catalytic subunit-like [Acyrtosiphon pisum]

comp5583\_c0\_seq1 CTP synthase [Nasonia vitripennis]

comp10714\_c0\_seq1 PREDICTED: similar to AGAP004271-PA [Tribolium castaneum] gi|270006251|gb|EFA02699.1| hypothetical protein TcasGA2\_TC008421 [Tribolium castaneum]

comp5175\_c0\_seq3 conserved hypothetical protein [Pediculus humanus corporis] gi|212508158|gb|EEB11927.1| conserved hypothetical protein [Pediculus humanus corporis]



comp1151\_c0\_seq1 hypothetical protein SINV\_07167 [Solenopsis invicta]

comp3329\_c0\_seq1 Signal recognition particle 14 kDa protein, putative [Pediculus humanus corporis] gi|212517121|gb|EEB19058.1| Signal recognition particle 14 kDa protein, putative [Pediculus humanus corporis]

comp1116\_c0\_seq2 hypothetical protein DAPPUDRAFT\_218652 [Daphnia pulex]

comp2077\_c0\_seq1

comp758\_c1\_seq4 GH14039 [Drosophila grimshawi] gi|193891834|gb|EDV90700.1| GH14039 [Drosophila grimshawi]

comp1458\_c0\_seq1 ribosomal protein L39, putative [Ixodes scapularis] gi|215510701|gb|EEC20154.1| ribosomal protein L39, putative [Ixodes scapularis]

comp6584\_c0\_seq1 conserved hypothetical protein [Pediculus humanus corporis] gi|212514903|gb|EEB17131.1| conserved hypothetical protein [Pediculus humanus corporis]

comp5881\_c0\_seq1 RNA-binding protein 28 [Camponotus floridanus] AGAP007998-PA [Anopheles gambiae str. PEST]

comp2422\_c0\_seq2 gi|116123253|gb|EAA12403.3| AGAP007998-PA [Anopheles gambiae str. PEST]

comp5456\_c0\_seq1 conserved hypothetical protein [Pediculus humanus corporis] gi|212505850|gb|EEB10208.1| conserved hypothetical protein [Pediculus humanus corporis]

comp97\_c0\_seq1

comp1028\_c0\_seq1 PREDICTED: similar to eIF3-S9 [Tribolium castaneum] gi|270011918|gb|EFA08366.1| hypothetical protein TcasGA2\_TC006009 [Tribolium castaneum]

comp3120\_c0\_seq1 PREDICTED: DNA ligase 1-like [Bombus terrestris]

comp2357\_c0\_seq1 WD-repeat protein YNL035C, putative [Pediculus humanus corporis] gi|212513065|gb|EEB15715.1| WD-repeat protein YNL035C, putative [Pediculus humanus corporis]

comp2796\_c0\_seq1 PREDICTED: similar to CG13472 CG13472-PA [Tribolium castaneum]

comp4899\_c0\_seq1 PREDICTED: similar to exosome component 8 [Tribolium castaneum] gi|270006123|gb|EFA02571.1| hypothetical protein TcasGA2\_TC008282 [Tribolium castaneum]

comp5337\_c0\_seq1 PREDICTED: hypothetical protein LOC408574 isoform 1 [Apis mellifera]

comp3516\_c0\_seq1

comp6743\_c0\_seq1 PREDICTED: seryl-tRNA synthetase, cytoplasmic-like [Acyrtosiphon pisum]

comp8270\_c1\_seq1 PREDICTED: transportin-1-like [Bombus terrestris]

comp6423\_c0\_seq1 hypothetical protein SINV\_14041 [Solenopsis invicta]

comp9560\_c0\_seq1 PREDICTED: Bloom syndrome protein homolog [Acyrtosiphon pisum]

comp3911\_c0\_seq1 phosphatidylethanolamine binding protein isoform 2 [Bombyx mori] gi|95102826|gb|ABF51354.1| phosphatidylethanolamine binding protein isoform 2 [Bombyx mori]

comp5048\_c0\_seq1 Conserved oligomeric Golgi complex subunit 6 [Camponotus floridanus]

comp4282\_c0\_seq2 PREDICTED: hypothetical protein [Nasonia vitripennis]

comp5467\_c0\_seq1 hypothetical protein SINV\_13915 [Solenopsis invicta]

comp4447\_c0\_seq1 PREDICTED: AP-3 complex subunit delta-1-like isoform 1 [Acyrtosiphon pisum]

comp6990\_c0\_seq1 PREDICTED: similar to AGAP001195-PA [Tribolium castaneum]

comp2132\_c0\_seq1 putative regulator of ribosome biosynthesis [Heliconius melpomene]

comp7456\_c0\_seq1 PREDICTED: probable tyrosyl-tRNA synthetase, mitochondrial-like [Acyrtosiphon pisum]

comp2094\_c0\_seq1 PREDICTED: growth/differentiation factor 3-like [Monodelphis domestica]

comp5712\_c0\_seq1 PREDICTED: hypothetical protein LOC100570013 [Acyrtosiphon pisum]

comp4842\_c0\_seq1 PHD finger protein 14 [Camponotus floridanus]

comp848\_c0\_seq1 PREDICTED: similar to aubergine [Nasonia vitripennis]

comp8352\_c1\_seq16 Collagen alpha-1(XV) chain [Acromyrmex echinator]

comp6594\_c0\_seq1 PREDICTED: similar to CG3894 CG3894-PA [Tribolium castaneum] gi|270010902|gb|EFA07350.1| hypothetical protein TcasGA2\_TC015949 [Tribolium castaneum]

comp10401\_c0\_seq1 PREDICTED: activating signal cointegrator 1 complex subunit 2-like [Bombus terrestris]

comp7828\_c0\_seq1 PREDICTED: similar to CG10470 CG10470-PA [Tribolium castaneum] gi|270007385|gb|EFA03833.1| hypothetical protein TcasGA2\_TC013949 [Tribolium castaneum]

comp2469\_c0\_seq1 hypothetical protein TcasGA2\_TC007276 [Tribolium castaneum]

comp5031\_c0\_seq1 Mitochondrial carrier-like protein 2 [Harpegnathos saltator]

comp3837\_c0\_seq2 PREDICTED: hypothetical protein LOC409240 [Apis mellifera]

comp5441\_c0\_seq1 PREDICTED: serine/threonine-protein kinase pelle-like [Acyrtosiphon pisum]

comp3834\_c0\_seq2 Arsenical pump-driving ATPase, putative [Pediculus humanus corporis] gi|212507576|gb|EEB11476.1| Arsenical pump-driving ATPase, putative [Pediculus humanus corporis]

comp2926\_c1\_seq2  
comp4158\_c0\_seq1 Splicing factor, putative [Pediculus humanus corporis]

comp3238\_c0\_seq1 gi|212513011|gb|EEB15661.1| Splicing factor, putative [Pediculus humanus corporis]

comp5092\_c0\_seq1 OTU domain-containing protein 6B [Acromyrmex echinator]

comp4076\_c0\_seq1 PREDICTED: microfibrillar-associated protein 1 [Apis mellifera]

comp7996\_c0\_seq1 hypothetical protein TcasGA2\_TC009196 [Tribolium castaneum]

comp4709\_c0\_seq1 FAD oxidoreductase [Culex quinquefasciatus] gi|167880398|gb|EDS43781.1| FAD oxidoreductase [Culex quinquefasciatus]

comp5152\_c0\_seq2 PREDICTED: similar to ran gtpase-activating protein [Tribolium castaneum] gi|270003723|gb|EFA00171.1| hypothetical protein TcasGA2\_TC002993 [Tribolium castaneum]

comp1623\_c0\_seq1 conserved hypothetical protein [Pediculus humanus corporis] gi|212516897|gb|EEB18851.1| conserved hypothetical protein [Pediculus humanus corporis]

comp770\_c0\_seq1 hypothetical protein EAI\_07906 [Harpegnathos saltator]

comp3260\_c0\_seq1 nuclear pore complex protein nup154, putative [Pediculus humanus corporis] gi|212512574|gb|EEB15317.1| nuclear pore complex protein nup154, putative [Pediculus humanus corporis]

comp4105\_c0\_seq1 PREDICTED: similar to cell division control protein [Tribolium castaneum] gi|270001087|gb|EEZ97534.1| hypothetical protein TcasGA2\_TC011382 [Tribolium castaneum]

comp3751\_c0\_seq1 hypothetical protein SINV\_02090 [Solenopsis invicta]

comp7210\_c0\_seq1 PREDICTED: protein scarlet-like [Bombus terrestris]

comp10534\_c0\_seq1 hypothetical protein TcasGA2\_TC015253 [Tribolium castaneum]

comp5930\_c0\_seq2 PREDICTED: 10-formyltetrahydrofolate dehydrogenase-like [Acyrtosiphon pisum]

comp16622\_c0\_seq1 uridine diphosphate glucosyltransferase [Bombyx mori] gi|213494483|gb|ACJ48963.1| uridine diphosphate glucosyltransferase [Bombyx mori]

comp9762\_c0\_seq1 hypothetical protein SINV\_00995 [Solenopsis invicta]

comp5382\_c0\_seq2 hypothetical protein DAPPUDRAFT\_213756 [Daphnia pulex]

comp3859\_c0\_seq1 mitochondrial ribosomal protein S31 [Tribolium castaneum] gi|270010145|gb|EFA06593.1| hypothetical protein TcasGA2\_TC009507 [Tribolium castaneum]

comp4619\_c0\_seq1 PREDICTED: similar to vesicle associated protein, putative [Tribolium castaneum]

comp413\_c0\_seq1

comp3056\_c1\_seq1

comp7983\_c0\_seq2 hypothetical protein BRAFLDRAFT\_114907 [Branchiostoma floridae] gi|229295831|gb|EEN66475.1| hypothetical protein BRAFLDRAFT\_114907 [Branchiostoma floridae]

comp6510\_c0\_seq1 PREDICTED: similar to cullin [Tribolium castaneum] gi|270008911|gb|EFA05359.1| hypothetical protein TcasGA2\_TC015524 [Tribolium castaneum]

comp5484\_c0\_seq1 Exosome complex exonuclease RRP46 [Acromyrmex echinatio]

comp7152\_c0\_seq1 tRNA-dihydrouridine synthase 3-like [Harpegnathos saltator]

comp4489\_c0\_seq1 viral A-type inclusion protein, putative [Acyrtosiphon pisum] gi|239792807|dbj|BAH72702.1| ACYPI001034 [Acyrtosiphon pisum]

comp6687\_c0\_seq1 PREDICTED: BTB/POZ domain-containing protein KCTD3-like [Acyrtosiphon pisum]

comp4532\_c0\_seq1 AGAP008118-PA [Anopheles gambiae str. PEST] gi|157015001|gb|EAA12568.4| AGAP008118-PA [Anopheles gambiae str. PEST]

comp3451\_c0\_seq2 N-terminal acetyltransferase complex Ard1 subunit, putative [Pediculus humanus corporis] gi|212510022|gb|EEB13282.1| N-terminal acetyltransferase complex Ard1 subunit, putative [Pediculus humanus corporis]

comp3813\_c0\_seq1 hypothetical protein DAPPUDRAFT\_60384 [Daphnia pulex]

comp7028\_c0\_seq2 Regulatory-associated protein of mTOR, putative [Pediculus humanus corporis] gi|212514611|gb|EEB16894.1| Regulatory-associated protein of mTOR, putative [Pediculus humanus corporis]

comp7138\_c0\_seq1 Mediator of RNA polymerase II transcription subunit 15 [Camponotus floridanus]  
 PREDICTED: bifunctional methylenetetrahydrofolate  
 comp7672\_c0\_seq1 dehydrogenase/cyclohydrolase, mitochondrial-like [Acyrtosiphon pisum]  
 comp6350\_c0\_seq1 hypothetical protein TcasGA2\_TC010433 [Tribolium castaneum]  
 comp5248\_c0\_seq1 Transcription initiation factor TFIID subunit 12 [Camponotus floridanus]  
 comp6317\_c0\_seq1 DEAD box ATP-dependent RNA helicase, putative [Pediculus humanus corporis] gi|212509065|gb|EEB12562.1| DEAD box ATP-dependent RNA helicase, putative [Pediculus humanus corporis]  
 comp3371\_c0\_seq1 Rpd3 histone deacetylase [Nasonia vitripennis]  
 comp4559\_c0\_seq1 PREDICTED: BTB (POZ) domain containing 2-like [Saccoglossus kowalevskii]  
 comp10922\_c0\_seq1 PREDICTED: similar to CG5978 CG5978-PA [Tribolium castaneum] gi|270004611|gb|EFA01059.1| hypothetical protein TcasGA2\_TC003977 [Tribolium castaneum]  
 comp1903\_c0\_seq1 conserved hypothetical protein [Pediculus humanus corporis] gi|212515794|gb|EEB17884.1| conserved hypothetical protein [Pediculus humanus corporis]  
 comp3512\_c0\_seq1 PREDICTED: coiled-coil domain-containing protein 6-like [Bombus terrestris]  
 comp4789\_c0\_seq1 116 kda U5 small nuclear ribonucleoprotein component [Aedes aegypti] gi|108872311|gb|EAT36536.1| 116 kda U5 small nuclear ribonucleoprotein component [Aedes aegypti]  
 comp10286\_c0\_seq1 hypothetical protein TcasGA2\_TC003335 [Tribolium castaneum]  
 comp11549\_c0\_seq1 PREDICTED: protein melted-like isoform 1 [Acyrtosiphon pisum]  
 comp5664\_c0\_seq2 hypothetical protein SALIVA\_1456 [Streptococcus salivarius JIM8777]  
 comp752\_c0\_seq1  
 comp7112\_c0\_seq1 PREDICTED: zinc finger protein 160-like [Acyrtosiphon pisum]  
 comp5531\_c0\_seq1 PREDICTED: WD repeat-containing protein 18-like [Acyrtosiphon pisum]  
 comp3331\_c0\_seq1 hypothetical protein TcasGA2\_TC013240 [Tribolium castaneum]  
 comp1332\_c0\_seq1 GJ13319 [Drosophila virilis] gi|194154378|gb|EDW69562.1| GJ13319 [Drosophila virilis]  
 comp1655\_c0\_seq1 PREDICTED: hypothetical protein LOC100161931 [Acyrtosiphon pisum]  
 comp7132\_c0\_seq3 conserved hypothetical protein [Pediculus humanus corporis] gi|212508467|gb|EEB12156.1| conserved hypothetical protein [Pediculus humanus corporis]  
 comp7636\_c0\_seq1  
 comp4369\_c0\_seq2 PREDICTED: facilitated trehalose transporter Tret1-like [Acyrtosiphon pisum]  
 comp2907\_c0\_seq1 Fas (TNFRSF6) associated factor 1 [Tribolium castaneum]  
 comp2784\_c1\_seq1  
 comp1331\_c1\_seq1 PREDICTED: polypyrimidine tract-binding protein 1-like isoform 1 [Acyrtosiphon pisum]

comp8368\_c0\_seq1 hypothetical protein Phum\_PHUM202100 [Pediculus humanus corporis] gi|212509291|gb|EEB12717.1| hypothetical protein Phum\_PHUM202100 [Pediculus humanus corporis]

comp2464\_c0\_seq1 PREDICTED: similar to 39S ribosomal protein L11, mitochondrial [Tribolium castaneum] gi|270010187|gb|EFA06635.1| hypothetical protein TcasGA2\_TC009555 [Tribolium castaneum]

comp4264\_c0\_seq1 PREDICTED: facilitated trehalose transporter Tret1-like [Acyrtosiphon pisum]

comp281\_c0\_seq1 putative ribosomal protein L28 [Diaphorina citri]

comp6138\_c0\_seq1 sumo-1-activating enzyme E1a, putative [Pediculus humanus corporis] gi|212514229|gb|EEB16588.1| sumo-1-activating enzyme E1a, putative [Pediculus humanus corporis]

comp2400\_c0\_seq1 conserved hypothetical protein [Pediculus humanus corporis] gi|212505846|gb|EEB10204.1| conserved hypothetical protein [Pediculus humanus corporis]

comp4318\_c0\_seq1 cell division control protein [Aedes aegypti] gi|108879911|gb|EAT44136.1| cell division control protein [Aedes aegypti]

comp6198\_c0\_seq1 PREDICTED: similar to protein kinase protein [Tribolium castaneum] gi|270013600|gb|EFA10048.1| hypothetical protein TcasGA2\_TC012222 [Tribolium castaneum]

comp4848\_c0\_seq1 PREDICTED: similar to alpha methylacyl-coa racemase [Tribolium castaneum] gi|270007738|gb|EFA04186.1| hypothetical protein TcasGA2\_TC014435 [Tribolium castaneum]

comp6357\_c0\_seq1 PREDICTED: similar to CG10225 CG10225-PA [Tribolium castaneum] gi|270013975|gb|EFA10423.1| hypothetical protein TcasGA2\_TC012664 [Tribolium castaneum]

comp11720\_c0\_seq1 PREDICTED: MGC80532 protein-like [Saccoglossus kowalevskii]

comp3323\_c0\_seq1 AGAP005961-PA [Anopheles gambiae str. PEST] gi|157015863|gb|EAA11702.5| AGAP005961-PA [Anopheles gambiae str. PEST]

comp2003\_c0\_seq1 PREDICTED: similar to proteasome beta subunit [Tribolium castaneum] gi|270003046|gb|EEZ99493.1| hypothetical protein TcasGA2\_TC000069 [Tribolium castaneum]

comp4701\_c0\_seq1 PREDICTED: DNA repair protein RAD50 isoform 1 [Equus caballus]

comp8294\_c0\_seq1 PREDICTED: hypothetical protein LOC100577295 [Apis mellifera]

comp247\_c0\_seq1 60s ribosomal protein L19 [Glossina morsitans morsitans]

comp1985\_c0\_seq1 PREDICTED: similar to protein phosphatase 2c gamma [Nasonia vitripennis]

comp2939\_c0\_seq1 eukaryotic translation initiation factor 6 [Saccoglossus kowalevskii]

comp2546\_c0\_seq1 PREDICTED: similar to ribophorin ii [Nasonia vitripennis]

comp3678\_c0\_seq1 PREDICTED: similar to G protein pathway suppressor 1 [Tribolium castaneum] gi|270004016|gb|EFA00464.1| hypothetical protein TcasGA2\_TC003322 [Tribolium castaneum]

comp214\_c1\_seq1 hypothetical protein SINV\_08497 [Solenopsis invicta]

comp617\_c0\_seq1 PREDICTED: upstream activation factor subunit spp27-like [Acyrtosiphon pisum]

comp2409\_c0\_seq1 cAMP-regulated phosphoprotein, putative [Pediculus humanus corporis] gi|212506043|gb|EEB10359.1| cAMP-regulated phosphoprotein, putative [Pediculus humanus corporis]

comp3045\_c0\_seq1 PREDICTED: similar to pebble CG8114-PB [Tribolium castaneum]

comp622\_c0\_seq1 nucleosome assembly protein 1-like isoform 2 [Nasonia vitripennis]

comp6066\_c0\_seq1 epsin 4/enthoprotin, putative [Pediculus humanus corporis] gi|212505926|gb|EEB10272.1| epsin 4/enthoprotin, putative [Pediculus humanus corporis]

comp5598\_c0\_seq1 hypothetical protein TcasGA2\_TC006403 [Tribolium castaneum]

comp4696\_c0\_seq1 Papain family cysteine protease containing protein [Tetrahymena thermophila] gi|89290066|gb|EAR88054.1| Papain family cysteine protease containing protein [Tetrahymena thermophila SB210]

comp20\_c0\_seq7

comp2068\_c0\_seq1 Probable small nuclear ribonucleoprotein Sm D2 [Harpegnathos saltator] gi|322786953|gb|EFZ13177.1| hypothetical protein SINV\_00701 [Solenopsis invicta]

comp3505\_c0\_seq1 sugar transporter [Culex quinquefasciatus] gi|167867183|gb|EDS30566.1| sugar transporter [Culex quinquefasciatus]

comp5759\_c0\_seq1 nucleoporin seh1, putative [Pediculus humanus corporis] gi|212509238|gb|EEB12683.1| nucleoporin seh1, putative [Pediculus humanus corporis]

comp11566\_c0\_seq1 sucrase [Acyrtosiphon pisum] gi|81159208|gb|ABB55878.1| sucrase [Acyrtosiphon pisum]

comp609\_c0\_seq2 PREDICTED: hypothetical protein [Nasonia vitripennis]

comp7178\_c0\_seq1 eukaryotic translation initiation factor 3 subunit, putative [Pediculus humanus corporis] gi|212514491|gb|EEB16805.1| eukaryotic translation initiation factor 3 subunit, putative [Pediculus humanus corporis]

comp5497\_c0\_seq1 PREDICTED: mitogen-activated protein kinase kinase kinase kinase 3-like isoform 1 [Acyrtosiphon pisum]

comp5918\_c0\_seq1 PREDICTED: prostatic acid phosphatase-like [Bombus terrestris]

comp6979\_c0\_seq1 PREDICTED: hypothetical protein LOC100642720 [Bombus terrestris]

comp1341\_c0\_seq3 Thioredoxin domain-containing protein 12 [Salmo salar] gi|221219350|gb|ACM08336.1| Thioredoxin domain-containing protein 12 precursor [Salmo salar]

comp7409\_c0\_seq1 conserved hypothetical protein [Pediculus humanus corporis] gi|212507988|gb|EEB11807.1| conserved hypothetical protein [Pediculus humanus corporis]

comp1297\_c0\_seq1 Interferon-inducible double stranded RNA-dependent protein kinase activator A [Camponotus floridanus]

comp7696\_c0\_seq1 PREDICTED: zinc finger protein 341-like [Apis mellifera]

comp715\_c0\_seq1

comp4265\_c0\_seq1 Enhancer of rudimentary homolog [Caligus clemensi]

comp9389\_c1\_seq1 PREDICTED: similar to MGC79091 protein [Tribolium castaneum] gi|270009431|gb|EFA05879.1| hypothetical protein TcasGA2\_TC008691 [Tribolium castaneum]

comp1541\_c0\_seq1  
 comp9720\_c0\_seq1 PREDICTED: protein lin-9 homolog [*Apis mellifera*]  
 comp2259\_c0\_seq1 PREDICTED: similar to arsenite-resistance protein [*Nasonia vitripennis*]  
 comp105\_c0\_seq1 hexamerin 1 [*Perla marginata*]  
 comp1934\_c0\_seq1  
 comp1215\_c0\_seq1 PREDICTED: hypothetical protein LOC100164801 isoform 2 [*Acyrtosiphon pisum*]  
 comp670\_c0\_seq1 PREDICTED: cytoplasmic aconitate hydratase-like [*Acyrtosiphon pisum*]  
 Sulfate permease, putative [*Pediculus humanus corporis*]  
 comp2897\_c0\_seq1 gi|212509207|gb|EEB12660.1| Sulfate permease, putative [*Pediculus humanus corporis*]  
 comp2266\_c1\_seq1 PREDICTED: hamartin-like [*Acyrtosiphon pisum*]  
 comp7128\_c0\_seq1 hypothetical protein PMAA\_098760 [*Penicillium marneffei* ATCC 18224] gi|210069195|gb|EEA23286.1| hypothetical protein PMAA\_098760 [*Penicillium marneffei* ATCC 18224]  
 comp3047\_c0\_seq1 PREDICTED: hypothetical protein LOC725524 [*Apis mellifera*]  
 comp10959\_c0\_seq1 phosphatidylinositol glycan [*Bombyx mori*] gi|95103156|gb|ABF51519.1| phosphatidylinositol glycan [*Bombyx mori*]  
 comp585\_c0\_seq1 translation initiation factor 5a-like [*Acyrtosiphon pisum*] gi|239788242|dbj|BAH70809.1| ACYP1002632 [*Acyrtosiphon pisum*]  
 comp5411\_c0\_seq1 Ferrochelatase, mitochondrial [*Camponotus floridanus*]  
 comp3085\_c0\_seq1 Replication protein A 32 kDa subunit [*Caligus rogercresseyi*]  
 comp3683\_c0\_seq1 PREDICTED: similar to GA21647-PA [*Nasonia vitripennis*]  
 comp8104\_c0\_seq1 PREDICTED: protein fat-free homolog [*Apis mellifera*]  
 comp4147\_c0\_seq1 PREDICTED: myosin-XVIIIa-like isoform 1 [*Bombus terrestris*]  
 comp5315\_c0\_seq1 GM18925 [*Drosophila sechellia*] gi|194121868|gb|EDW43911.1| GM18925 [*Drosophila sechellia*]  
 comp6451\_c0\_seq2 PREDICTED: sodium/calcium exchanger 1-like [*Acyrtosiphon pisum*]  
 comp4326\_c0\_seq1 PREDICTED: coatomer subunit zeta-1 isoform 1 [*Apis mellifera*]  
 comp4143\_c0\_seq1 PREDICTED: DNA-directed RNA polymerase II subunit RPB3-like [*Apis mellifera*]  
 comp1556\_c0\_seq1 26S proteasome non-ATPase regulatory subunit, putative [*Pediculus humanus corporis*] gi|212512219|gb|EEB15027.1| 26S proteasome non-ATPase regulatory subunit, putative [*Pediculus humanus corporis*]  
 comp4459\_c0\_seq1 RhoA activator C11orf59-like protein [*Acromyrmex echinator*]  
 comp1730\_c0\_seq1 26S protease regulatory subunit 6B, putative [*Pediculus humanus corporis*] gi|212511194|gb|EEB14227.1| 26S protease regulatory subunit 6B, putative [*Pediculus humanus corporis*]  
 comp11527\_c0\_seq1 PREDICTED: laccase-4-like [*Bombus terrestris*]  
 comp10948\_c0\_seq1 Tetratricopeptide repeat protein 35-B [*Camponotus floridanus*]  
 comp1214\_c0\_seq1

comp6258\_c0\_seq2 eukaryotic translation initiation factor 4 gamma [Nasonia vitripennis]  
 PREDICTED: similar to sorting nexin isoform 1 [Tribolium castaneum]

comp4285\_c0\_seq6 gi|270009518|gb|EFA05966.1| hypothetical protein  
 TcasGA2\_TC008785 [Tribolium castaneum]

comp1896\_c0\_seq1 Stathmin-4 [Acromyrmex echinator]

comp3385\_c0\_seq1 eukaryotic translation initiation factor 2A [Nasonia vitripennis]

comp338\_c0\_seq1 vitellogenin [Nilaparvata lugens]  
 PREDICTED: cytoplasmic dynein 1 light intermediate chain 2 [Apis mellifera]

comp5037\_c0\_seq1 PREDICTED: GPN-loop GTPase 3-like [Apis mellifera]  
 PREDICTED: similar to AGAP008909-PA [Tribolium castaneum]

comp4534\_c0\_seq1 gi|270016373|gb|EFA12819.1| hypothetical protein  
 TcasGA2\_TC001886 [Tribolium castaneum]

comp4033\_c0\_seq1 PREDICTED: LOW QUALITY PROTEIN: nuclear pore complex  
 protein Nup153-like [Bombus terrestris]

comp6367\_c0\_seq1 PREDICTED: ribosome biogenesis protein BOP1 homolog [Bombus terrestris]

comp4798\_c0\_seq1 clathrin coat assembly protein ap-1, putative [Pediculus humanus corporis] gi|212507089|gb|EEB11117.1| clathrin coat assembly  
 protein ap-1, putative [Pediculus humanus corporis]  
 PREDICTED: similar to zinc finger protein [Tribolium castaneum]

comp3656\_c0\_seq1 gi|270009543|gb|EFA05991.1| hypothetical protein  
 TcasGA2\_TC008817 [Tribolium castaneum]

comp5914\_c0\_seq1 hypothetical protein DAPPUDRAFT\_319459 [Daphnia pulex]

comp324\_c0\_seq1 PREDICTED: 60S ribosomal protein L17-like [Acyrtosiphon pisum]

comp6707\_c0\_seq1 PREDICTED: hypothetical protein LOC100165548 isoform 2  
 [Acyrtosiphon pisum]  
 PREDICTED: similar to karyopherin alpha 6 [Tribolium castaneum]

comp6458\_c0\_seq1 gi|270002024|gb|EEZ98471.1| hypothetical protein  
 TcasGA2\_TC000963 [Tribolium castaneum]  
 amidohydrolase [Spirosoma linguale DSM 74]

comp6210\_c0\_seq1 gi|283819176|gb|ADB41014.1| amidohydrolase [Spirosoma linguale  
 DSM 74]

comp2743\_c0\_seq1

comp9641\_c0\_seq1 KRAB-zinc finger protein [Mus musculus]

comp1690\_c0\_seq1 Translocon-associated protein subunit alpha [Harpegnathos saltator]

comp5855\_c0\_seq1 RNA polymerase II-associated factor 1-like protein [Harpegnathos  
 saltator]

comp687\_c0\_seq2 hypothetical protein TcasGA2\_TC012700 [Tribolium castaneum]

comp59\_c0\_seq1 vitellogenin [Athalia rosae]  
 GF17194 [Drosophila ananassae]  
 gi|313471310|sp|B3M098.1|MTNA\_DROAN RecName:  
 Full=Methylthioribose-1-phosphate isomerase; Short=M1Pi;  
 Short=MTR-1-P isomerase; AltName: Full=S-methyl-5-thioribose-1-  
 phosphate isomerase; AltName: Full=Translation initiation factor eIF-  
 2B subunit alpha/beta/delta-like protein  
 &gt;gi|190626531|gb|EDV42055.1| GF17194 [Drosophila ananassae]



comp7204\_c0\_seq1 PREDICTED: hypothetical protein LOC100160456 [*Acyrtosiphon pisum*]

comp48\_c0\_seq1 PREDICTED: transcription initiation factor IIA subunit 1 isoform 2 [*Apis mellifera*]

comp4293\_c0\_seq1 glutamate carboxypeptidase [*Culex quinquefasciatus*]  
gi|167881720|gb|EDS45103.1| glutamate carboxypeptidase [*Culex quinquefasciatus*]

comp6097\_c0\_seq1 COP9 signalosome complex subunit, putative [*Pediculus humanus corporis*] gi|212514024|gb|EEB16413.1| COP9 signalosome complex subunit, putative [*Pediculus humanus corporis*]

comp326\_c0\_seq1 vitellogenin [*Trigonotylus caelestialium*]

comp7428\_c0\_seq1 target of rapamycin [*Blattella germanica*]

comp5273\_c0\_seq1

comp7807\_c0\_seq1 hypothetical protein SINV\_07805 [*Solenopsis invicta*]

comp7816\_c0\_seq2 PREDICTED: serine/threonine-protein kinase PAK 1-like [*Acyrtosiphon pisum*]

comp307\_c0\_seq2

comp5040\_c0\_seq1 Histone deacetylase complex subunit SAP18 [*Harpegnathos saltator*]

comp189\_c0\_seq1 PREDICTED: similar to translation elongation factor 2 [*Nasonia vitripennis*]

comp6975\_c0\_seq1 Transcription initiation factor TFIID subunit 4 [*Harpegnathos saltator*]

comp8780\_c0\_seq1 S-phase kinase-associated protein 1 [*Caligus rogercresseyi*]  
gi|225710690|gb|ACO11191.1| S-phase kinase-associated protein 1 [*Caligus rogercresseyi*] &gt;gi|225714348|gb|ACO13020.1| S-phase kinase-associated protein 1 [*Lepeophtheirus salmonis*]  
&gt;gi|225719430|gb|ACO15561.1| S-phase kinase-associated protein 1 [*Caligus clemensi*] &gt;gi|290561056|gb|ADD37930.1| S-phase kinase-associated protein 1 [*Lepeophtheirus salmonis*]

comp10588\_c0\_seq1 ankyrin repeat protein [*Trichomonas vaginalis* G3]  
gi|121891508|gb|EAX96837.1| ankyrin repeat protein, putative [*Trichomonas vaginalis* G3]

comp872\_c0\_seq3 zinc finger protein CCCH domain-containing protein, putative [*Pediculus humanus corporis*] gi|212508278|gb|EEB12026.1| zinc finger protein CCCH domain-containing protein, putative [*Pediculus humanus corporis*]

comp8984\_c0\_seq1 PREDICTED: cytochrome b5 reductase 3-like [*Saccoglossus kowalevskii*]

comp4017\_c0\_seq1 PREDICTED: dynamin related protein 1 isoform 1 [*Apis mellifera*]

comp5081\_c0\_seq1 PREDICTED: similar to histidine triad protein member [*Tribolium castaneum*]

comp2809\_c0\_seq1 N-acetyltransferase-like [*Acyrtosiphon pisum*]  
gi|239789332|dbj|BAH71296.1| ACYPI004487 [*Acyrtosiphon pisum*]

comp1848\_c0\_seq1 PREDICTED: ribosomal L1 domain-containing protein CG13096-like [*Bombus terrestris*]

comp509\_c0\_seq2 chemosensory protein 5 [*Apis mellifera*]  
gi|112031616|gb|ABH88173.1| chemosensory protein 5 [*Apis mellifera*]

comp4780\_c0\_seq1 PREDICTED: DNA-directed RNA polymerase III subunit RPC1-like [Bombus terrestris]

comp406\_c0\_seq4 PREDICTED: hypothetical protein LOC100650971 [Bombus terrestris]

comp7119\_c0\_seq1 Protein kinase C-binding protein 1 [Acromyrmex echinator]

comp2036\_c0\_seq1 aldehyde dehydrogenase [Aedes aegypti]  
gi|108869413|gb|EAT33638.1| aldehyde dehydrogenase [Aedes aegypti]

comp1867\_c0\_seq1 PREDICTED: ubiquitin carboxyl-terminal hydrolase 3-like [Bombus terrestris]

comp223\_c0\_seq1 hypothetical protein SINV\_04528 [Solenopsis invicta]

comp211\_c0\_seq1 60S ribosomal protein L23-like protein [Phlebotomus papatasi]

comp5455\_c0\_seq1 PREDICTED: PHD finger and CXXC domain-containing protein CG17446-like [Bombus terrestris]

comp7459\_c0\_seq1 PREDICTED: similar to conserved hypothetical protein [Nasonia vitripennis]

comp4272\_c0\_seq1 PREDICTED: probable dynactin subunit 2-like [Bombus terrestris]

comp2216\_c0\_seq1 Putative serine protease F56F10.1 [Camponotus floridanus]

comp5577\_c0\_seq1 PREDICTED: PMS1 protein homolog 1-like [Acyrtosiphon pisum]

comp5001\_c0\_seq1 hypothetical protein EAG\_01480 [Camponotus floridanus]

comp9053\_c0\_seq1 PREDICTED: similar to coproporphyrinogen iii oxidase [Nasonia vitripennis]

comp5272\_c0\_seq1

comp348\_c0\_seq4 putative ribosomal protein L11 [Maconellicoccus hirsutus]  
AGAP005188-PA [Anopheles gambiae str. PEST]

comp8694\_c0\_seq1 gi|157017129|gb|EAA09500.5| AGAP005188-PA [Anopheles gambiae str. PEST]

comp8774\_c0\_seq1 Pre-mRNA-splicing factor RBM22 [Camponotus floridanus]

comp4313\_c0\_seq1 PREDICTED: DNA-directed RNA polymerase III subunit RPC2-like [Bombus terrestris]

comp5189\_c0\_seq1 Protein transport protein Sec24B [Camponotus floridanus]

comp2754\_c0\_seq1 PREDICTED: zinc finger protein Xfin-like [Acyrtosiphon pisum]

comp2614\_c0\_seq1 hypothetical protein G5I\_09090 [Acromyrmex echinator]  
PREDICTED: similar to predicted protein [Tribolium castaneum]

comp2212\_c0\_seq1 gi|270012608|gb|EFA09056.1| hypothetical protein TcasGA2\_TC006771 [Tribolium castaneum]

comp5737\_c0\_seq1 PREDICTED: hypothetical protein LOC100165457 [Acyrtosiphon pisum]

comp7090\_c0\_seq1 Probable JmjC domain-containing histone demethylation protein 3B [Camponotus floridanus]

comp8283\_c0\_seq1 PREDICTED: arginyl-tRNA--protein transferase 1 [Monodelphis domestica]

comp411\_c0\_seq1 lupus la ribonucleoprotein [Aedes aegypti]  
gi|108880822|gb|EAT45047.1| lupus la ribonucleoprotein [Aedes aegypti]

60S ribosomal protein L9 [Aedes aegypti]  
gi|157116673|ref|XP\_001652828.1| 60S ribosomal protein L9 [Aedes aegypti] &gt;gi|157116675|ref|XP\_001652829.1| 60S ribosomal protein L9 [Aedes aegypti] &gt;gi|157116677|ref|XP\_001652830.1| 60S ribosomal protein L9 [Aedes aegypti] &gt;gi|94468812|gb|ABF18255.1| ribosomal protein L9 [Aedes aegypti] &gt;gi|108876350|gb|EAT40575.1| 60S ribosomal protein L9 [Aedes aegypti] &gt;gi|108876351|gb|EAT40576.1| 60S ribosomal protein L9 [Aedes aegypti] &gt;gi|108876352|gb|EAT40577.1| 60S ribosomal protein L9 [Aedes aegypti] &gt;gi|108876353|gb|EAT40578.1| 60S ribosomal protein L9 [Aedes aegypti]

comp481\_c0\_seq1

predicted protein [Nematostella vectensis]  
gi|156222627|gb|EDO43469.1| predicted protein [Nematostella vectensis]

comp1938\_c0\_seq1

hypothetical protein TcasGA2\_TC012601 [Tribolium castaneum]

comp7510\_c0\_seq1

hypothetical protein SINV\_12193 [Solenopsis invicta]

comp1911\_c0\_seq1

PREDICTED: 26S proteasome non-ATPase regulatory subunit 10-like [Acyrtosiphon pisum]

comp8706\_c0\_seq1

DNA replication licensing factor MCM5 [Aedes aegypti]  
gi|108881751|gb|EAT45976.1| DNA replication licensing factor MCM5 [Aedes aegypti]

comp4248\_c0\_seq1

PREDICTED: hypothetical protein LOC551973 [Apis mellifera]

comp1414\_c0\_seq2

PREDICTED: similar to restricted expression proliferation associated protein-100 [Strongylocentrotus purpuratus]  
gi|115926901|ref|XP\_001196535.1| PREDICTED: similar to restricted expression proliferation associated protein-100 [Strongylocentrotus purpuratus]

comp2067\_c0\_seq1

vitellogenin [Trigonotylus caelestialium]

comp314\_c0\_seq1

hypothetical protein AaeL\_AAEL000965 [Aedes aegypti]  
gi|108883769|gb|EAT47994.1| conserved hypothetical protein [Aedes aegypti]

comp10244\_c0\_seq1

PREDICTED: THUMP domain-containing protein 1-like [Bombus terrestris]

comp2965\_c0\_seq1

phosphatidylethanolamine-binding protein [Branchiostoma belcheri tsingtauense]

comp5298\_c0\_seq1

pre-mRNA-splicing factor ATP-dependent RNA helicase prp16, putative [Pediculus humanus corporis] gi|212511335|gb|EEB14339.1| pre-mRNA-splicing factor ATP-dependent RNA helicase prp16, putative [Pediculus humanus corporis]

comp5413\_c0\_seq1

hypothetical protein LOC100135267 [Xenopus (Silurana) tropicalis]  
gi|163916166|gb|AAI57556.1| LOC100135267 protein [Xenopus (Silurana) tropicalis]

comp7161\_c0\_seq1

PREDICTED: pyridine nucleotide-disulfide oxidoreductase domain-containing protein 1-like [Bombus terrestris]

comp2269\_c0\_seq1

comp4647\_c0\_seq1

Protein CASC3 [Harpegnathos saltator]

comp3430\_c0\_seq2

import inner membrane translocase subunit TIM50-C, putative [Pediculus humanus corporis] gi|212513414|gb|EEB15991.1| import inner membrane translocase subunit TIM50-C, putative [Pediculus humanus corporis]

comp3481\_c0\_seq1

comp8033\_c0\_seq1 PREDICTED: WD repeat and HMG-box DNA-binding protein 1-like [Acyrtosiphon pisum]

comp5314\_c0\_seq1 Transcription initiation factor TFIID subunit 5 [Acromyrmex echinator]

comp5008\_c0\_seq1 putative deoxyribose-phosphate aldolase [Gallus gallus]  
gi|53127188|emb|CAG31017.1| hypothetical protein RCJMB04\_1j17 [Gallus gallus]

comp2654\_c0\_seq1

comp8825\_c0\_seq1 PREDICTED: similar to GA18517-PA [Nasonia vitripennis]

comp3118\_c0\_seq1 PREDICTED: similar to conserved hypothetical protein [Nasonia vitripennis]

comp10936\_c0\_seq1 hypothetical protein SINV\_06875 [Solenopsis invicta]

comp10587\_c0\_seq1 DNA repair and recombination protein RAD26, putative [Pediculus humanus corporis] gi|212510049|gb|EEB13301.1| DNA repair and recombination protein RAD26, putative [Pediculus humanus corporis]

comp3483\_c0\_seq1 splicing factor u2af large subunit [Aedes aegypti]  
gi|108881728|gb|EAT45953.1| splicing factor u2af large subunit [Aedes aegypti]

comp7239\_c0\_seq1 PREDICTED: LOW QUALITY PROTEIN: DNA mismatch repair protein Msh2-like [Bombus terrestris]

comp4732\_c0\_seq1 PREDICTED: similar to GA21059-PA [Nasonia vitripennis]

comp337\_c0\_seq1 PREDICTED: similar to Haspin CG40080-PA [Tribolium castaneum]

comp8330\_c0\_seq1 PREDICTED: PH-interacting protein [Apis mellifera]

comp8989\_c0\_seq1 Metallophosphoesterase [Wolbachia endosymbiont of Culex quinquefasciatus Pel] gi|213019031|ref|ZP\_03334838.1| Metallophosphoesterase [Wolbachia endosymbiont of Culex quinquefasciatus JHB] &gt;gi|190357901|emb|CAQ55361.1| Metallophosphoesterase [Wolbachia endosymbiont of Culex quinquefasciatus Pel] &gt;gi|212995140|gb|EEB55781.1| Metallophosphoesterase [Wolbachia endosymbiont of Culex quinquefasciatus JHB]

comp5482\_c0\_seq1 hypothetical protein AaeL\_AAEL013304 [Aedes aegypti]  
gi|108870227|gb|EAT34452.1| conserved hypothetical protein [Aedes aegypti]

comp3121\_c0\_seq1 hypothetical protein DAPPUDRAFT\_302851 [Daphnia pulex]

comp373\_c1\_seq3

comp6845\_c0\_seq2 PREDICTED: similar to AGAP001629-PA [Tribolium castaneum]  
gi|270008427|gb|EFA04875.1| hypothetical protein TcasGA2\_TC014933 [Tribolium castaneum]

comp3058\_c0\_seq2

comp11869\_c0\_seq1 PREDICTED: hypothetical protein [Nasonia vitripennis]

comp7041\_c0\_seq1 hypothetical protein TcasGA2\_TC014807 [Tribolium castaneum]

comp2406\_c0\_seq1 PREDICTED: similar to Parn-A protein [Tribolium castaneum]  
gi|270011407|gb|EFA07855.1| hypothetical protein TcasGA2\_TC005425 [Tribolium castaneum]

comp3920\_c0\_seq1 hypothetical protein [Trichomonas vaginalis G3]  
gi|121890508|gb|EAX95880.1| hypothetical protein TVAG\_008910 [Trichomonas vaginalis G3]

comp6309\_c1\_seq1 PREDICTED: similar to inhibitor of growth family, member 1 [Tribolium castaneum] gi|270005646|gb|EFA02094.1| hypothetical protein TcasGA2\_TC007731 [Tribolium castaneum]

comp4381\_c0\_seq1 PREDICTED: Carbohydrate kinase domain-containing protein-like [Oryctolagus cuniculus]

comp2693\_c0\_seq1 PREDICTED: similar to GTP-binding protein [Tribolium castaneum] gi|270008006|gb|EFA04454.1| hypothetical protein TcasGA2\_TC014758 [Tribolium castaneum]

comp1864\_c0\_seq1 PREDICTED: similar to metalloprotease [Tribolium castaneum] gi|270001475|gb|EEZ97922.1| hypothetical protein TcasGA2\_TC000308 [Tribolium castaneum]

comp1173\_c0\_seq1 T-complex protein 1 subunit theta, putative [Pediculus humanus corporis] gi|212509512|gb|EEB12881.1| T-complex protein 1 subunit theta, putative [Pediculus humanus corporis]

comp7841\_c0\_seq1 serine/threonine-protein kinase VRK1, putative [Pediculus humanus corporis] gi|212515273|gb|EEB17444.1| serine/threonine-protein kinase VRK1, putative [Pediculus humanus corporis]

comp7498\_c0\_seq1 PREDICTED: similar to conserved hypothetical protein [Nasonia vitripennis]

comp2875\_c0\_seq1 GM16890 [Drosophila sechellia] gi|194130073|gb|EDW52116.1| GM16890 [Drosophila sechellia]

comp205\_c0\_seq1 PREDICTED: similar to ribosomal protein S5 [Nasonia vitripennis]

comp5982\_c0\_seq1 PREDICTED: similar to DNA replication licensing factor MCM3 [Tribolium castaneum] gi|270015933|gb|EFA12381.1| hypothetical protein TcasGA2\_TC002088 [Tribolium castaneum]

comp447\_c0\_seq1 Inositol monophosphatase [Camponotus floridanus]

comp3219\_c0\_seq1 Ubiquitin carboxyl-terminal hydrolase 32 [Harpegnathos saltator]

comp5225\_c0\_seq1 PREDICTED: hypothetical protein LOC100636472 [Amphimedon queenslandica]

comp10352\_c0\_seq1 PREDICTED: bone morphogenetic protein 3-like [Oryctolagus cuniculus]

comp11047\_c0\_seq1 AGAP004465-PA [Anopheles gambiae str. PEST] gi|55240843|gb|EAA09266.2| AGAP004465-PA [Anopheles gambiae str. PEST]

comp3210\_c0\_seq4 glucose transporter, putative [Pediculus humanus corporis] gi|212517330|gb|EEB19241.1| glucose transporter, putative [Pediculus humanus corporis]

comp5462\_c0\_seq1 pre-mRNA-splicing factor clf-1, putative [Pediculus humanus corporis] gi|212509867|gb|EEB13153.1| pre-mRNA-splicing factor clf-1, putative [Pediculus humanus corporis]

comp8057\_c0\_seq1 hypothetical protein AaeL\_AAEL002691 [Aedes aegypti] gi|108881878|gb|EAT46103.1| conserved hypothetical protein [Aedes aegypti]

comp4332\_c0\_seq1 Brain tumor protein [Harpegnathos saltator]

comp3447\_c0\_seq1 DnaJ domain containing protein [Heliconius melpomene]

comp3332\_c0\_seq1 N-myristoyltransferase, putative [Glyptapanteles indiensis]

comp6144\_c0\_seq1 PREDICTED: BAG family molecular chaperone regulator 2-like [Apis mellifera]

comp6807\_c0\_seq1 conserved hypothetical protein [Culex quinquefasciatus]  
 gi|167862652|gb|EDS26035.1| conserved hypothetical protein [Culex quinquefasciatus]

comp6836\_c0\_seq1 hypothetical protein FOXB\_13274 [Fusarium oxysporum Fo5176]

comp3555\_c0\_seq1 cell division cycle 20 [Acyrtosiphon pisum]

comp5641\_c0\_seq1 XPA-binding protein 1 [Culex quinquefasciatus]  
 gi|167873024|gb|EDS36407.1| XPA-binding protein 1 [Culex quinquefasciatus]

comp3312\_c0\_seq1 JAB-MPN domain protein [Bombyx mori]  
 gi|221579605|gb|ACM24339.1| JAB-MPN domain protein [Bombyx mori]

comp4545\_c0\_seq1 p21-activated protein kinase-interacting protein 1-like protein [Acromyrmex echinator]

comp10743\_c0\_seq1 sentrin/sumo-specific protease, putative [Pediculus humanus corporis]  
 gi|212518562|gb|EEB20308.1| sentrin/sumo-specific protease, putative [Pediculus humanus corporis]

comp392\_c0\_seq1 nucleoplasmin isoform 1-like protein [Maconellicoccus hirsutus]

comp3848\_c0\_seq1 Protein 4.1-like protein [Harpegnathos saltator]

comp7610\_c0\_seq1 PREDICTED: kanadaplin [Acyrtosiphon pisum]

comp1846\_c0\_seq1 PREDICTED: similar to proteasome zeta subunit [Tribolium castaneum]  
 gi|270009423|gb|EFA05871.1| hypothetical protein TcasGA2\_TC008671 [Tribolium castaneum]

comp9351\_c0\_seq1 PREDICTED: transcription elongation factor B polypeptide 3-like [Bombus terrestris]

comp178\_c0\_seq1 40S ribosomal protein S8 [Triatoma infestans]

comp1628\_c0\_seq1 hypothetical protein SINV\_09873 [Solenopsis invicta]

comp6409\_c0\_seq2 Symplekin, putative [Pediculus humanus corporis]  
 gi|212512753|gb|EEB15463.1| Symplekin, putative [Pediculus humanus corporis]

comp8083\_c0\_seq1 GA14724 [Drosophila pseudoobscura pseudoobscura]  
 gi|198132043|gb|EAL28047.2| GA14724 [Drosophila pseudoobscura pseudoobscura]

comp5832\_c0\_seq1 PREDICTED: similar to lachesin [Tribolium castaneum]  
 gi|270008732|gb|EFA05180.1| hypothetical protein TcasGA2\_TC015310 [Tribolium castaneum]

comp556\_c0\_seq3 PREDICTED: ATP-dependent RNA helicase p62-like isoform 1 [Acyrtosiphon pisum]

comp8734\_c0\_seq1 PREDICTED: hypothetical protein LOC100161816 [Acyrtosiphon pisum]

comp9867\_c0\_seq1 PREDICTED: probable ATP-dependent RNA helicase DDX11-like [Acyrtosiphon pisum]

comp9088\_c0\_seq1 PREDICTED: WD40 repeat-containing protein SMU1-like isoform 1 [Apis mellifera]

comp2679\_c0\_seq1 GATAd [Tribolium castaneum]

comp4767\_c0\_seq1 PREDICTED: similar to Bm44 [Nasonia vitripennis]

comp551\_c0\_seq1 ribosomal protein L23A [Triatoma matogrossensis]

comp648\_c0\_seq1 PREDICTED: probable nucleolar GTP-binding protein 1-like [Acyrtosiphon pisum]

comp394\_c0\_seq1 vitellogenin [Trigonotylus caelestialium]

comp4244\_c0\_seq1 PREDICTED: protein LTV1 homolog [Acyrtosiphon pisum]

comp12137\_c0\_seq1 PREDICTED: LOW QUALITY PROTEIN: phosphatidylinositol-4-phosphate 3-kinase C2 domain-containing subunit beta-like [Bombus terrestris]

comp2966\_c0\_seq1 zinc finger protein 14 [*Culex quinquefasciatus*]  
 gi|167876615|gb|EDS39998.1| zinc finger protein 14 [*Culex quinquefasciatus*]  
 comp4660\_c0\_seq1  
 comp3722\_c0\_seq1 GI19579 [*Drosophila mojavensis*] gi|193909571|gb|EDW08438.1|  
 GI19579 [*Drosophila mojavensis*]  
 comp8014\_c0\_seq1 Huntingtin [*Camponotus floridanus*]  
 comp5529\_c0\_seq1 PREDICTED: similar to replication factor C, 37-kDa subunit, putative  
 [*Tribolium castaneum*] gi|270006308|gb|EFA02756.1| hypothetical  
 protein TcasGA2\_TC008489 [*Tribolium castaneum*]  
 comp233\_c0\_seq1 ribosomal protein S10 [*Chrysomela tremulae*]  
 comp1357\_c0\_seq2 PREDICTED: similar to conserved hypothetical protein [*Nasonia vitripennis*]  
 comp11484\_c0\_seq1 Melanotransferrin [*Camponotus floridanus*]  
 comp5657\_c0\_seq4 Phosphatidylinositol N-acetylglucosaminyltransferase subunit Q  
 [*Harpegnathos saltator*]  
 ribosomal protein S15Aa, isoform D [*Drosophila melanogaster*]  
 gi|24641743|ref|NP\_727690.1| ribosomal protein S15Aa, isoform A  
 [*Drosophila melanogaster*] &gt;gi|24641747|ref|NP\_727692.1|  
 ribosomal protein S15Aa, isoform C [*Drosophila melanogaster*]  
 &gt;gi|24641750|ref|NP\_727693.1| ribosomal protein S15Aa, isoform  
 E [*Drosophila melanogaster*] &gt;gi|281360807|ref|NP\_001162738.1|  
 ribosomal protein S15Aa, isoform F [*Drosophila melanogaster*]  
 &gt;gi|125983534|ref|XP\_001355532.1| GA15195 [*Drosophila*  
*pseudoobscura pseudoobscura*]  
 &gt;gi|194768000|ref|XP\_001966102.1| GF19502 [*Drosophila*  
*ananassae*] &gt;gi|194895562|ref|XP\_001978283.1| GG19508  
 [*Drosophila erecta*] &gt;gi|195059055|ref|XP\_001995555.1| GH17815  
 [*Drosophila grimshawi*] &gt;gi|195133640|ref|XP\_002011247.1|  
 GI16425 [*Drosophila mojavensis*]  
 &gt;gi|195168739|ref|XP\_002025188.1| GL26726 [*Drosophila*  
*persimilis*] &gt;gi|195352846|ref|XP\_002042922.1| GM11496  
 [*Drosophila sechellia*] &gt;gi|195398721|ref|XP\_002057969.1|  
 GJ15828 [*Drosophila virilis*] &gt;gi|195456726|ref|XP\_002075260.1|  
 GK16027 [*Drosophila willistoni*]  
 &gt;gi|195478247|ref|XP\_002100454.1| RpS15Aa [*Drosophila*  
*yakuba*] &gt;gi|195566562|ref|XP\_002106849.1| GD15889  
 [*Drosophila simulans*] &gt;gi|1350954|sp|P48149.2|RS15A\_DROME  
 RecName: Full=40S ribosomal protein S15Aa  
 &gt;gi|60396627|sp|Q6XIM8.3|RS15A\_DROYA RecName: Full=40S  
 ribosomal protein S15a &at:dil311606|embl|CAA79771.1| ribosomal  
 10 kDa heat shock protein, putative [*Pediculus humanus corporis*]  
 gi|212513354|gb|EEB15945.1| 10 kDa heat shock protein, putative  
 [*Pediculus humanus corporis*]  
 comp519\_c0\_seq1  
 comp3363\_c0\_seq1 PREDICTED: DNA-directed RNA polymerase III subunit RPC5-like  
 [*Bombus terrestris*]  
 elongation factor 1 alpha [*Gryllus bimaculatus*]  
 comp45\_c0\_seq1 gi|305377018|dbj|BAJ15872.1| elongation factor 1 alpha [*Gryllus*  
*bimaculatus*]  
 comp3074\_c0\_seq1 PREDICTED: similar to CG1078 CG1078-PA [*Tribolium castaneum*]  
 gi|270006693|gb|EFA03141.1| hypothetical protein  
 TcasGA2\_TC013053 [*Tribolium castaneum*]  
 comp440\_c0\_seq6 ubiquitin-protein ligase/zinc ion binding protein [*Triticum aestivum*]

comp8334\_c0\_seq1 conserved hypothetical protein [Pediculus humanus corporis] gi|212508879|gb|EEB12439.1| conserved hypothetical protein [Pediculus humanus corporis]

comp9691\_c0\_seq1 golgi-specific brefeldin A-resistance guanine nucleotide exchange factor, putative [Pediculus humanus corporis] gi|212515878|gb|EEB17950.1| golgi-specific brefeldin A-resistance guanine nucleotide exchange factor, putative [Pediculus humanus corporis]

comp6255\_c0\_seq1 hypothetical protein SINV\_05429 [Solenopsis invicta]

comp5609\_c0\_seq1 PREDICTED: u3 small nucleolar RNA-associated protein 15 homolog [Apis mellifera]

comp4595\_c0\_seq1 PREDICTED: signal recognition particle 72 kDa protein-like [Apis mellifera]

comp2854\_c0\_seq1

comp6471\_c0\_seq2 PREDICTED: LOW QUALITY PROTEIN: integrator complex subunit 3 homolog [Bombus terrestris]

comp3330\_c0\_seq1 PREDICTED: c-Myc-binding protein-like [Bombus terrestris]

comp7200\_c0\_seq1 PREDICTED: lymphoid-specific helicase-like [Acyrtosiphon pisum]

comp576\_c0\_seq2

comp2436\_c0\_seq1 PREDICTED: midasin-like [Bombus terrestris]

comp1739\_c0\_seq1

comp4845\_c0\_seq1 secreted protein [Ixodes scapularis] gi|215505493|gb|EEC14987.1| secreted protein [Ixodes scapularis]

comp2791\_c0\_seq1 lysine-specific histone demethylase, putative [Ixodes scapularis] gi|215501670|gb|EEC11164.1| lysine-specific histone demethylase, putative [Ixodes scapularis]

comp7622\_c0\_seq3 PREDICTED: ethanolaminephosphotransferase 1-like [Acyrtosiphon pisum]

comp4324\_c0\_seq1 PREDICTED: 28S ribosomal protein S35, mitochondrial-like [Acyrtosiphon pisum]

comp7418\_c0\_seq1 PREDICTED: similar to Zinc finger protein 43 (Zinc finger protein 39) (Zinc protein HTF6) (Zinc finger protein KOX27) [Tribolium castaneum]

comp3888\_c0\_seq1 thymidine kinase-like [Acyrtosiphon pisum] gi|239790179|dbj|BAH71666.1| ACYPI006294 [Acyrtosiphon pisum]

comp5074\_c0\_seq1

comp2325\_c0\_seq1 PREDICTED: peptidyl-prolyl cis-trans isomerase FKBP2-like [Acyrtosiphon pisum]

comp5454\_c0\_seq1 AGAP005341-PA [Anopheles gambiae str. PEST] gi|157015371|gb|EDO63649.1| AGAP005341-PA [Anopheles gambiae str. PEST]

comp194\_c0\_seq1 PREDICTED: similar to rap55 [Nasonia vitripennis]

comp5711\_c0\_seq1 PREDICTED: similar to Zinc finger RAD18 domain-containing protein C1orf124 [Tribolium castaneum] gi|270004629|gb|EFA01077.1| hypothetical protein TcasGA2\_TC003998 [Tribolium castaneum]

comp2877\_c0\_seq1 hypothetical protein TcasGA2\_TC006313 [Tribolium castaneum]

comp1610\_c0\_seq2

comp1658\_c0\_seq1

comp3073\_c0\_seq1 PREDICTED: putative U5 small nuclear ribonucleoprotein 200 kDa helicase-like [Bombus terrestris]



comp693\_c0\_seq1 PREDICTED: hypothetical protein LOC100168603 isoform 1 [Acyrtosiphon pisum] gi|328717699|ref|XP\_003246281.1|  
 PREDICTED: hypothetical protein LOC100168603 isoform 2 [Acyrtosiphon pisum]

comp8688\_c0\_seq1 hect E3 ubiquitin ligase, putative [Pediculus humanus corporis] gi|212512172|gb|EEB14993.1| hect E3 ubiquitin ligase, putative [Pediculus humanus corporis]

comp4142\_c0\_seq1 Peptidyl-prolyl cis-trans isomerase-like 4 [Acromyrmex echinator]

comp2284\_c0\_seq1 39S ribosomal protein L13-like [Acyrtosiphon pisum] gi|239789841|dbj|BAH71519.1| ACYPI007195 [Acyrtosiphon pisum]

comp1166\_c0\_seq1 putative RNA polymerase II transcriptional coactivator [Antheraea yamamai]

comp3850\_c0\_seq1 formin 1,2/cappuccino, putative [Pediculus humanus corporis] gi|212518364|gb|EEB20117.1| formin 1,2/cappuccino, putative [Pediculus humanus corporis]

comp6512\_c0\_seq1 PREDICTED: transcription termination factor 2-like isoform 1 [Acyrtosiphon pisum] gi|328713458|ref|XP\_003245082.1|  
 PREDICTED: transcription termination factor 2-like isoform 2 [Acyrtosiphon pisum]

comp6779\_c0\_seq1 PREDICTED: facilitated trehalose transporter Tret1-like [Acyrtosiphon pisum]

comp5828\_c0\_seq1 Nuclear pore complex protein Nup133, putative [Pediculus humanus corporis] gi|212516399|gb|EEB18412.1| Nuclear pore complex protein Nup133, putative [Pediculus humanus corporis]

comp6009\_c0\_seq2 conserved hypothetical protein [Pediculus humanus corporis] gi|212515980|gb|EEB18045.1| conserved hypothetical protein [Pediculus humanus corporis]

comp243\_c0\_seq1  
 comp3268\_c0\_seq1

comp3755\_c0\_seq1 hypothetical protein BRAFLDRAFT\_66468 [Branchiostoma floridae] gi|229282591|gb|EEN53340.1| hypothetical protein BRAFLDRAFT\_66468 [Branchiostoma floridae]

comp5509\_c0\_seq1 conserved hypothetical protein [Pediculus humanus corporis] gi|212517725|gb|EEB19564.1| conserved hypothetical protein [Pediculus humanus corporis]

comp603\_c0\_seq1 Protein shuttle craft [Harpegnathos saltator]

comp3004\_c0\_seq1 PREDICTED: hypothetical protein LOC100166196 [Acyrtosiphon pisum]

comp8246\_c0\_seq1 PREDICTED: tripartite motif-containing 3-like [Saccoglossus kowalevskii]

comp3572\_c0\_seq2 PREDICTED: hypothetical protein LOC100651932 [Bombus terrestris]

comp1366\_c0\_seq1 hypothetical protein SINV\_04585 [Solenopsis invicta]

comp9335\_c0\_seq1 protein EMSY, putative [Ixodes scapularis] gi|215499195|gb|EEC08689.1| protein EMSY, putative [Ixodes scapularis]

comp6148\_c0\_seq1 Probable cleavage and polyadenylation specificity factor subunit 2 [Camponotus floridanus]

comp3308\_c0\_seq1 translation initiation factor-3 (IF3), putative [Aedes aegypti] gi|108876153|gb|EAT40378.1| translation initiation factor-3 (IF3), putative [Aedes aegypti]

comp4643\_c0\_seq3 PREDICTED: patched domain-containing protein 3-like [Acyrtosiphon pisum]  
 comp8229\_c0\_seq1 PREDICTED: chromatin accessibility complex protein 1-like [Apis mellifera]  
 comp6245\_c0\_seq1 Wolframin [Camponotus floridanus]  
 comp3333\_c0\_seq1 hypothetical protein SINV\_07726 [Solenopsis invicta]  
 comp6354\_c0\_seq2 PREDICTED: REST corepressor 3-like isoform 4 [Bombus terrestris]  
 comp6637\_c0\_seq1 daughter of sevenless-like [Nasonia vitripennis]  
 comp10431\_c0\_seq1 PREDICTED: LOW QUALITY PROTEIN: tetratricopeptide repeat protein 28-like [Bombus terrestris]  
 comp4699\_c0\_seq1 hypothetical protein DAPPUDRAFT\_300799 [Daphnia pulex]  
 comp6773\_c0\_seq1 PREDICTED: regulator complex protein LAMTOR3-A-like [Apis mellifera]  
 comp2354\_c0\_seq1 Alpha-aminoacidic semialdehyde synthase, mitochondrial [Camponotus floridanus]  
 comp1356\_c0\_seq1 PREDICTED: SAFB-like transcription modulator-like [Apis mellifera]  
 comp4795\_c0\_seq1 fmr [Gryllus bimaculatus]  
 comp4199\_c0\_seq5 PREDICTED: splicing factor, arginine/serine-rich 18-like [Apis mellifera]  
 comp6221\_c0\_seq1 PREDICTED: similar to MGC84305 protein [Strongylocentrotus purpuratus] gi|115970867|ref|XP\_001190992.1| PREDICTED: similar to MGC84305 protein [Strongylocentrotus purpuratus]  
 comp2928\_c3\_seq2 PREDICTED: probable ATP-dependent RNA helicase DDX52-like [Bombus terrestris]  
 comp1022\_c0\_seq1 PREDICTED: similar to chaperonin [Tribolium castaneum] gi|270002664|gb|EEZ99111.1| hypothetical protein TcasGA2\_TC005004 [Tribolium castaneum]  
 comp792\_c0\_seq1 PREDICTED: proliferation-associated protein 2G4-like [Bombus terrestris]  
 comp5721\_c0\_seq1 GK10605 [Drosophila willistoni] gi|194164145|gb|EDW79046.1| GK10605 [Drosophila willistoni]  
 comp11284\_c0\_seq1 enhancer of filamentation 1 [Apis mellifera]  
 comp2998\_c0\_seq1 PREDICTED: similar to protein phosphatase-5 [Tribolium castaneum] gi|270009672|gb|EFA06120.1| hypothetical protein TcasGA2\_TC008963 [Tribolium castaneum]  
 comp6968\_c0\_seq1 PREDICTED: nuclear pore complex protein Nup160 homolog [Acyrtosiphon pisum]  
 comp5540\_c0\_seq1 GE18291 [Drosophila yakuba] gi|194174027|gb|EDW87638.1| GE18291 [Drosophila yakuba]  
 comp5239\_c0\_seq1 THO complex subunit 1 [Harpegnathos saltator]  
 comp3933\_c0\_seq1 mex-3 protein [Tribolium castaneum] gi|218464687|emb|CAM28380.2| KH domain protein [Tribolium castaneum]  
 comp4289\_c0\_seq1 PREDICTED: probable ATP-dependent RNA helicase DDX28-like [Acyrtosiphon pisum]  
 comp1211\_c0\_seq4 structure specific recognition protein-like [Acyrtosiphon pisum]  
 comp5713\_c0\_seq1 GH22229 [Drosophila grimshawi] gi|193895784|gb|EDV94650.1| GH22229 [Drosophila grimshawi]

comp10204\_c0\_seq1 PREDICTED: similar to plexin A CG11081-PA [Tribolium castaneum]  
gi|270015104|gb|EFA11552.1| plexin A [Tribolium castaneum]

comp5616\_c0\_seq1 glycerol kinase [Aedes aegypti] gi|108879512|gb|EAT43737.1|  
glycerol kinase [Aedes aegypti]

comp2506\_c0\_seq1 Coatomer subunit beta&apos;, putative [Pediculus humanus corporis]  
gi|212508406|gb|EEB12118.1| Coatomer subunit beta&apos;, putative  
[Pediculus humanus corporis]

comp442\_c0\_seq1 ribosomal protein S29 [Chrysomela tremulae]

comp3276\_c0\_seq1 Ubiquitin thioesterase otubain-like [Camponotus floridanus]

comp3250\_c0\_seq1 PREDICTED: similar to delta-aminolevulinatase dehydratase [Nasonia  
vitripennis]

comp4947\_c0\_seq1 PREDICTED: glutathione S-transferase omega-1-like [Bombus  
terrestris]

comp2482\_c0\_seq1 Guanine nucleotide-binding protein-like 1 [Camponotus floridanus]

comp1362\_c0\_seq2 PREDICTED: similar to GA11814-PA [Tribolium castaneum]  
gi|270004178|gb|EFA00626.1| hypothetical protein  
TcasGA2\_TC003502 [Tribolium castaneum]

comp4544\_c0\_seq1 pentatricopeptide repeat domain 1 [Acyrtosiphon pisum]  
hypothetical protein AaeL\_AAEL011476 [Aedes aegypti]

comp9343\_c0\_seq1 gi|94469314|gb|ABF18506.1| hypothetical conserved protein [Aedes  
aegypti] &gt;gi|108872218|gb|EAT36443.1| conserved hypothetical  
protein [Aedes aegypti]

comp3218\_c0\_seq1 Cullin-associated NEDD8-dissociated protein, putative [Pediculus  
humanus corporis] gi|212518736|gb|EEB20457.1| Cullin-associated  
NEDD8-dissociated protein, putative [Pediculus humanus corporis]

comp11108\_c0\_seq1

comp5371\_c0\_seq2 conserved hypothetical protein [Pediculus humanus corporis]  
gi|212508750|gb|EEB12347.1| conserved hypothetical protein  
[Pediculus humanus corporis]

comp1622\_c1\_seq1 RecName: Full=Heterogeneous nuclear ribonucleoprotein A1, A2/B1  
homolog gi|10107|emb|CAA38481.1| mammalian A1, A2 /B1 hnRNP  
homologue [Schistocerca americana]

comp8897\_c0\_seq1 ornithine cyclodeaminase, putative [Pediculus humanus corporis]  
gi|212509614|gb|EEB12975.1| ornithine cyclodeaminase, putative  
[Pediculus humanus corporis]

comp318\_c0\_seq3

comp6933\_c0\_seq1 PREDICTED: similar to CG3172-PA [Nasonia vitripennis]

comp3443\_c0\_seq1 hypothetical protein DAPPUDRAFT\_218645 [Daphnia pulex]

comp3974\_c0\_seq1 hypothetical protein AND\_13423 [Anopheles darlingi]

comp3386\_c0\_seq1 PREDICTED: similar to cleavage stimulation factor 64-kDa subunit  
[Nasonia vitripennis]  
mcfdp2, putative [Pediculus humanus corporis]

comp1849\_c0\_seq4 gi|212514434|gb|EEB16758.1| mcfdp2, putative [Pediculus humanus  
corporis]

comp2511\_c0\_seq1 PREDICTED: OV-16 antigen-like [Apis mellifera]

comp1659\_c0\_seq1 hypothetical protein SINV\_11622 [Solenopsis invicta]

comp1195\_c0\_seq1 Protein bicaudal C [Harpegnathos saltator]

comp6834\_c0\_seq1 PREDICTED: hypothetical protein LOC100571834 [Acyrtosiphon  
pisum]

comp8066\_c0\_seq2 PREDICTED: hypothetical protein LOC100163498 isoform 1 [Acyrtosiphon pisum]

comp3002\_c0\_seq1 PREDICTED: kinesin-like protein KIF2A-like isoform 1 [Acyrtosiphon pisum]

comp4340\_c0\_seq1 PREDICTED: hypothetical protein LOC100162351 [Acyrtosiphon pisum]

comp5974\_c0\_seq1 Putative helicase Mov10l1 [Acromyrmex echinator]

comp8094\_c0\_seq1 PREDICTED: similar to pinn [Tribolium castaneum]

comp136\_c0\_seq1 60S ribosomal protein L27a [Brugia malayi]  
gi|158601982|gb|EDP38710.1| 60S ribosomal protein L27a, putative [Brugia malayi]

comp2421\_c0\_seq1 PREDICTED: pescadillo homolog [Bombus terrestris]

comp6345\_c0\_seq1 PREDICTED: similar to conserved hypothetical protein [Tribolium castaneum] gi|270012614|gb|EFA09062.1| hypothetical protein TcasGA2\_TC006777 [Tribolium castaneum]

comp5534\_c0\_seq1 sin3a-associated protein sap130, putative [Pediculus humanus corporis] gi|212508545|gb|EEB12193.1| sin3a-associated protein sap130, putative [Pediculus humanus corporis]

comp5525\_c0\_seq1 hypothetical protein TcasGA2\_TC030645 [Tribolium castaneum]

comp2359\_c0\_seq1 PREDICTED: similar to Rpt1 CG1341-PA [Tribolium castaneum] gi|270012350|gb|EFA08798.1| hypothetical protein TcasGA2\_TC006492 [Tribolium castaneum]

comp4148\_c0\_seq1 Cell division cycle 2-like protein kinase 5 [Camponotus floridanus]

comp5062\_c0\_seq1 GH12492 [Drosophila grimshawi] gi|193900864|gb|EDV99730.1| GH12492 [Drosophila grimshawi]

comp1811\_c0\_seq1 PREDICTED: 26S proteasome non-ATPase regulatory subunit 2-like [Acyrtosiphon pisum]

comp4648\_c0\_seq1 PREDICTED: 39S ribosomal protein L44, mitochondrial-like [Acyrtosiphon pisum]

comp5564\_c0\_seq1 PREDICTED: similar to zinc finger, AN1 type domain 2B [Tribolium castaneum] gi|270005743|gb|EFA02191.1| hypothetical protein TcasGA2\_TC007847 [Tribolium castaneum]

comp1191\_c0\_seq1

comp982\_c0\_seq2 Putative glycerol kinase 3 [Camponotus floridanus]

comp6689\_c0\_seq1 G patch domain-containing protein 1-like protein [Acromyrmex echinator]

comp13084\_c0\_seq3 PREDICTED: myosin-XV isoform 1 [Acyrtosiphon pisum]

comp5412\_c0\_seq1 PREDICTED: notchless protein homolog 1-like [Acyrtosiphon pisum]

comp16275\_c0\_seq1 Brefeldin A-inhibited guanine nucleotide-exchange protein, putative [Pediculus humanus corporis] gi|212509094|gb|EEB12582.1| Brefeldin A-inhibited guanine nucleotide-exchange protein, putative [Pediculus humanus corporis]

comp660\_c0\_seq1 E1b-55kD-associated protein, putative [Pediculus humanus corporis] gi|212508552|gb|EEB12200.1| E1b-55kD-associated protein, putative [Pediculus humanus corporis]

comp1263\_c0\_seq1 PREDICTED: similar to CG10206 [Nasonia vitripennis]

comp11663\_c0\_seq1 hypothetical protein TcasGA2\_TC010431 [Tribolium castaneum]

comp2015\_c0\_seq1 PREDICTED: fumarylacetoacetate hydrolase domain-containing protein 2-like [Acyrtosiphon pisum]

comp5372\_c0\_seq1 PREDICTED: pre-mRNA branch site p14-like protein-like [Apis mellifera]

comp2057\_c0\_seq4 Blimp-1 [Tribolium castaneum]

comp7285\_c0\_seq2 PREDICTED: similar to MTA1-like CG2244-PB [Tribolium castaneum]  
gi|270009558|gb|EFA06006.1| hypothetical protein  
TcasGA2\_TC008832 [Tribolium castaneum]

comp8465\_c0\_seq1 cytochrome P450 [Bemisia tabaci]

comp6413\_c0\_seq2 PREDICTED: DNA polymerase delta subunit 2-like [Acyrtosiphon pisum]

comp3126\_c0\_seq1 PREDICTED: similar to mitotic checkpoint protein and poly(a)+ RNA export protein [Nasonia vitripennis]

comp3455\_c0\_seq1 PREDICTED: similar to dolichyl-phosphate mannosyltransferase [Tribolium castaneum]

comp9468\_c0\_seq1 GK12556 [Drosophila willistoni] gi|194163804|gb|EDW78705.1|  
GK12556 [Drosophila willistoni]

comp196\_c0\_seq1 PREDICTED: similar to ribosome-associated protein P40 [Tribolium castaneum] gi|270012401|gb|EFA08849.1| hypothetical protein  
TcasGA2\_TC006550 [Tribolium castaneum]

comp4961\_c0\_seq1 PREDICTED: similar to nuclear import 7 homolog [Tribolium castaneum] gi|270016870|gb|EFA13316.1| hypothetical protein  
TcasGA2\_TC006900 [Tribolium castaneum]

comp4698\_c0\_seq1 conserved hypothetical protein [Rickettsia endosymbiont of Ixodes scapularis] gi|239922565|gb|EER22589.1| conserved hypothetical protein [Rickettsia endosymbiont of Ixodes scapularis]

comp9863\_c0\_seq2 PREDICTED: similar to procollagen-lysine,2-oxoglutarate 5-dioxygenase [Nasonia vitripennis]

comp10934\_c0\_seq1 conserved hypothetical protein [Pediculus humanus corporis] gi|212517537|gb|EEB19417.1| conserved hypothetical protein [Pediculus humanus corporis]

comp7172\_c0\_seq1 PREDICTED: LOW QUALITY PROTEIN: cirhin-like [Bombus terrestris]

comp4401\_c0\_seq1 hypothetical protein AND\_06035 [Anopheles darlingi]

comp5687\_c0\_seq1 PREDICTED: BRCA1-associated protein-like [Bombus terrestris]

comp8039\_c0\_seq1 conserved hypothetical protein [Ruminococcus sp. 5\_1\_39B\_FAA] gi|251847969|gb|EES75935.1| conserved hypothetical protein [Ruminococcus sp. 5\_1\_39BFAA]

comp1829\_c0\_seq1 nucleolar phosphoprotein [Bombyx mori] gi|109706827|gb|ABG43000.1| nucleolar phosphoprotein [Bombyx mori]

comp1330\_c0\_seq1 uv excision repair protein rad23, putative [Pediculus humanus corporis] gi|212517628|gb|EEB19493.1| uv excision repair protein rad23, putative [Pediculus humanus corporis]

comp6288\_c0\_seq1 PREDICTED: similar to CG7488 CG7488-PA [Tribolium castaneum] gi|270011756|gb|EFA08204.1| hypothetical protein  
TcasGA2\_TC005831 [Tribolium castaneum]

comp5247\_c0\_seq1 Fizzy-related protein-like protein [Harpegnathos saltator]

comp1411\_c0\_seq1 PREDICTED: similar to GA11007-PA [Nasonia vitripennis]

comp3645\_c0\_seq1 hypothetical protein SINV\_01596 [Solenopsis invicta]

comp4999\_c0\_seq1 ACYPI001763 [Acyrtosiphon pisum]

comp1699\_c0\_seq1 PREDICTED: similar to formin 1,2/cappuccino [Tribolium castaneum] gi|270014279|gb|EFA10727.1| cappuccino [Tribolium castaneum]

comp6038\_c0\_seq1 PREDICTED: similar to pom1 [Nasonia vitripennis]

comp5494\_c0\_seq1 RNA-binding protein with serine-rich domain 1 [Dicentrarchus labrax]

comp1035\_c0\_seq1 PREDICTED: hypothetical protein LOC726887 [Apis mellifera]

comp1487\_c0\_seq1 viral A-type inclusion protein [Trichomonas vaginalis G3] gi|121905960|gb|EAY10879.1| viral A-type inclusion protein, putative [Trichomonas vaginalis G3]

comp7726\_c0\_seq1 PREDICTED: similar to virilizer CG3496-PA [Tribolium castaneum] gi|270003474|gb|EEZ99921.1| hypothetical protein TcasGA2\_TC002713 [Tribolium castaneum]

comp6380\_c0\_seq1 PREDICTED: tetratricopeptide repeat protein 27-like [Acyrtosiphon pisum]

comp6180\_c0\_seq1 PREDICTED: similar to NC2alpha CG10318-PA [Tribolium castaneum]

comp8904\_c0\_seq1 GF18252 [Drosophila ananassae] gi|190627455|gb|EDV42979.1| GF18252 [Drosophila ananassae]

comp6113\_c0\_seq1 DNA polymerase delta catalytic subunit [Bemisia tabaci]

comp1347\_c0\_seq1

comp3713\_c0\_seq1 COP9 signalosome complex subunit, putative [Pediculus humanus corporis] gi|212506922|gb|EEB10993.1| COP9 signalosome complex subunit, putative [Pediculus humanus corporis]

comp7875\_c0\_seq1 PREDICTED: tubulin gamma-1 chain isoform 1 [Apis mellifera]

comp5810\_c0\_seq1 inositol monophosphatase family domain containing protein [Pediculus humanus corporis] gi|212513972|gb|EEB16370.1| inositol monophosphatase family domain containing protein [Pediculus humanus corporis]

comp194\_c0\_seq2 PREDICTED: similar to rap55 [Nasonia vitripennis]

comp604\_c0\_seq1 PREDICTED: similar to eukaryotic translation initiation factor 3, theta subunit [Tribolium castaneum] gi|270013675|gb|EFA10123.1| hypothetical protein TcasGA2\_TC012303 [Tribolium castaneum]

comp1715\_c0\_seq1

comp318\_c0\_seq1

comp7134\_c0\_seq1 PREDICTED: uncharacterized protein C12orf4 homolog [Apis mellifera]

comp2061\_c0\_seq1 eukaryotic translation initiation factor 3 subunit 12-like protein [Triatoma infestans]

comp4707\_c0\_seq1 PREDICTED: deoxynucleotidyltransferase terminal-interacting protein 2-like [Bombus terrestris]

comp7641\_c0\_seq1 Nucleoporin Nup37 [Camponotus floridanus]

comp7717\_c0\_seq1

comp8148\_c0\_seq1 PREDICTED: similar to CG10903 CG10903-PA [Tribolium castaneum] gi|270008360|gb|EFA04808.1| hypothetical protein TcasGA2\_TC014857 [Tribolium castaneum]

comp5488\_c0\_seq1 Nuclear nucleic acid-binding protein C1D [Camponotus floridanus]

comp5144\_c0\_seq1 GK18401 [Drosophila willistoni] gi|194171583|gb|EDW86484.1| GK18401 [Drosophila willistoni]

comp8981\_c0\_seq1 PREDICTED: similar to ENSANGP00000023686 [Nasonia vitripennis]

comp3486\_c0\_seq1

comp6677\_c0\_seq1 secreted phosphatidylethanolamine binding protein [Glossina morsitans morsitans]

comp2058\_c1\_seq1 Folate receptor alpha precursor, putative [Pediculus humanus corporis] gi|212515246|gb|EEB17417.1| Folate receptor alpha precursor, putative [Pediculus humanus corporis]

comp179\_c0\_seq1 GJ17775 [Drosophila virilis] gi|194149287|gb|EDW64985.1| GJ17775 [Drosophila virilis]

comp5161\_c0\_seq1 wd-repeat protein [Aedes aegypti] gi|122106389|sp|Q17BB0.1|WDR12\_AEDAE RecName: Full=Ribosome biogenesis protein WDR12 homolog &gt;gi|108879311|gb|EAT43536.1| wd-repeat protein [Aedes aegypti]

comp10400\_c0\_seq1 phosphatidylethanolamine-binding protein [Aedes aegypti] gi|108870917|gb|EAT35142.1| phosphatidylethanolamine-binding protein [Aedes aegypti]

comp6000\_c0\_seq1 DEP domain containing 1a [Danio rerio]

comp2228\_c0\_seq1

comp9008\_c0\_seq1 PREDICTED: cryptochrome-1-like [Bombus terrestris]

comp4165\_c0\_seq1 PREDICTED: similar to Phosphorylated adaptor for RNA export, putative [Tribolium castaneum] gi|270009528|gb|EFA05976.1| hypothetical protein TcasGA2\_TC008802 [Tribolium castaneum]

comp7753\_c0\_seq1 Protein FAM50-like protein [Harpegnathos saltator]

comp8738\_c0\_seq1 probable O-sialoglycoprotein endopeptidase [Acyrtosiphon pisum] gi|239790727|dbj|BAH71906.1| ACYP1004911 [Acyrtosiphon pisum]

comp7575\_c0\_seq1 putative H3K9 methyltransferase [Lepisma saccharina]

comp3138\_c0\_seq1 PREDICTED: probable ATP-dependent RNA helicase pitchoune-like [Bombus terrestris]

comp41\_c0\_seq6 PREDICTED: similar to nucleolar KKE/D repeat protein; DmNOP56 [Nasonia vitripennis]

comp15893\_c0\_seq1 hypothetical protein Phum\_PHUM299820 [Pediculus humanus corporis] gi|212511457|gb|EEB14436.1| hypothetical protein Phum\_PHUM299820 [Pediculus humanus corporis]

**comp1157\_c0\_seq1** transformer-2 sex-determining protein, putative [Pediculus humanus corporis] gi|212517371|gb|EEB19282.1| transformer-2 sex-determining protein, putative [Pediculus humanus corporis]

comp1586\_c0\_seq1 Tubulin beta-6 chain [Dicentrarchus labrax]

comp4903\_c0\_seq1 Metaxin-1, putative [Pediculus humanus corporis] gi|212513912|gb|EEB16319.1| Metaxin-1, putative [Pediculus humanus corporis]

comp10024\_c0\_seq1 Exosome component 10 [Acromyrmex echinatior]

comp4028\_c0\_seq1 ankyrin repeat protein [Trichomonas vaginalis G3] gi|121912377|gb|EAY17199.1| ankyrin repeat protein, putative [Trichomonas vaginalis G3]

comp4714\_c0\_seq1 PREDICTED: ruvB-like 2-like [Bombus terrestris]

comp5099\_c0\_seq1 NEDD8-activating enzyme E1 regulatory subunit [Camponotus floridanus]

comp9803\_c0\_seq1 PREDICTED: polyphosphoinositide phosphatase [Apis mellifera]

comp10399\_c0\_seq1 PREDICTED: DNA helicase INO80-like [Bombus terrestris]

comp6369\_c0\_seq1 PREDICTED: apoptosis-inducing factor 1, mitochondrial isoform 2 [Acyrtosiphon pisum]

comp11706\_c1\_seq1 PREDICTED: similar to tuberin [Tribolium castaneum]

comp2080\_c0\_seq1 Transcription factor GATA-4 [Camponotus floridanus]

comp906\_c0\_seq1 Hrp65 protein, putative [Pediculus humanus corporis]  
gi|212515645|gb|EEB17750.1| Hrp65 protein, putative [Pediculus humanus corporis]

comp13\_c0\_seq1 GA28568 [Drosophila pseudoobscura pseudoobscura]  
gi|198151215|gb|EDY74106.1| GA28568 [Drosophila pseudoobscura pseudoobscura]

comp1789\_c0\_seq1 PREDICTED: eukaryotic translation initiation factor 4H-like [Apis mellifera]

comp1400\_c0\_seq1

comp4498\_c0\_seq1

comp3328\_c0\_seq1 PREDICTED: similar to GA18228-PA [Nasonia vitripennis]

comp2963\_c0\_seq1 PREDICTED: hypothetical protein LOC100160600 [Acyrtosiphon pisum]

comp9159\_c0\_seq1 conserved hypothetical protein [Pediculus humanus corporis]  
gi|212517061|gb|EEB19008.1| conserved hypothetical protein [Pediculus humanus corporis]

comp2794\_c0\_seq1 PREDICTED: similar to histone H1 [Nasonia vitripennis]

comp2209\_c0\_seq1 hypothetical protein SINV\_15099 [Solenopsis invicta]

comp5874\_c0\_seq1 PREDICTED: f-box only protein 22 [Macaca mulatta]

comp7349\_c0\_seq1 hypothetical protein DAPPUDRAFT\_302493 [Daphnia pulex]

comp2948\_c0\_seq1 Coatomer subunit gamma-2, putative [Pediculus humanus corporis]  
gi|212511156|gb|EEB14189.1| Coatomer subunit gamma-2, putative [Pediculus humanus corporis]

comp12319\_c0\_seq1 zinc finger protein RTS2, putative [Pediculus humanus corporis]  
gi|212514394|gb|EEB16724.1| zinc finger protein RTS2, putative [Pediculus humanus corporis]

comp2864\_c0\_seq1 mitochondrial ribosomal protein L37 [Nasonia vitripennis]

comp11451\_c0\_seq1 PREDICTED: periodic tryptophan protein 2 homolog [Apis mellifera]

comp6284\_c0\_seq1 Exportin-2 [Harpegnathos saltator]

comp4382\_c0\_seq1 PREDICTED: sorting nexin-6-like [Acyrtosiphon pisum]

comp9893\_c0\_seq1 WD-repeat protein, putative [Pediculus humanus corporis]  
gi|212507706|gb|EEB11568.1| WD-repeat protein, putative [Pediculus humanus corporis]

comp7138\_c0\_seq2 PREDICTED: similar to DnaJ-like protein [Tribolium castaneum]  
gi|270007594|gb|EFA04042.1| hypothetical protein TcasGA2\_TC014273 [Tribolium castaneum]

comp5322\_c0\_seq1 PREDICTED: protein spinster-like [Acyrtosiphon pisum]

comp2002\_c0\_seq1 clathrin coat associated protein ap-50 [Aedes aegypti]  
gi|108881420|gb|EAT45645.1| clathrin coat associated protein ap-50 [Aedes aegypti]

comp2625\_c1\_seq1 PREDICTED: hypothetical protein LOC100163820 [Acyrtosiphon pisum]

comp5367\_c1\_seq2 hypothetical protein TcasGA2\_TC013167 [Tribolium castaneum]





comp8302\_c0\_seq1 Transcription initiation factor TFIID subunit 6 [Camponotus floridanus]  
 comp3739\_c0\_seq1 PREDICTED: ubiquitin carboxyl-terminal hydrolase 5-like isoform 1 [Bombus terrestris]  
 comp4668\_c0\_seq1 Arfaptin-2 [Camponotus floridanus]  
 comp2805\_c0\_seq1 Brix domain-containing protein 1-like protein [Camponotus floridanus]  
 comp4261\_c0\_seq1 hypothetical protein AND\_24115 [Anopheles darlingi]  
 comp3618\_c0\_seq1 Serine/threonine-protein kinase TAO1 [Acromyrmex echinator]  
  
 comp6344\_c0\_seq1 DNA polymerase subunit gamma 1, mitochondrial [Culex quinquefasciatus] gi|167873869|gb|EDS37252.1| DNA polymerase subunit gamma 1, mitochondrial [Culex quinquefasciatus]  
 comp3341\_c0\_seq1 PREDICTED: hypothetical protein LOC100165888 [Acyrtosiphon pisum]  
 comp321\_c0\_seq1  
 comp3174\_c0\_seq1 PREDICTED: similar to mitochondrial ribosomal protein S2 CG2937-PA [Tribolium castaneum] gi|270003534|gb|EEZ99981.1| hypothetical protein TcasGA2\_TC002780 [Tribolium castaneum]  
  
 comp3839\_c0\_seq1 membrane-associated protein, putative [Pediculus humanus corporis] gi|212516187|gb|EEB18229.1| membrane-associated protein, putative [Pediculus humanus corporis]  
  
 comp6190\_c0\_seq1 PREDICTED: transcription initiation factor TFIID subunit 7 isoform 2 [Apis mellifera]  
 comp6688\_c0\_seq1 UPF0539 protein CG14977 [Harpegnathos saltator]  
 comp7430\_c0\_seq1 PREDICTED: centromere/kinetochore protein zw10 homolog [Apis mellifera]  
 comp485\_c0\_seq1 E3 ubiquitin ligase [Cimex lectularius]  
 comp7865\_c0\_seq1 hypothetical protein TcasGA2\_TC009313 [Tribolium castaneum]  
 comp171\_c0\_seq2  
 comp2569\_c0\_seq1 hypothetical protein AND\_11649 [Anopheles darlingi]  
 comp4335\_c0\_seq1 mitochondrial import receptor subunit tom40 [Aedes aegypti] gi|108877122|gb|EAT41347.1| mitochondrial import receptor subunit tom40 [Aedes aegypti]  
 comp6332\_c0\_seq1 conserved hypothetical protein [Culex quinquefasciatus] gi|167862630|gb|EDS26013.1| conserved hypothetical protein [Culex quinquefasciatus]  
 comp234\_c0\_seq1 ribosomal protein S27 [Xenopsylla cheopis]  
  
 comp3706\_c0\_seq2 PREDICTED: similar to phosphoinositide-binding protein, putative [Tribolium castaneum] gi|270006674|gb|EFA03122.1| hypothetical protein TcasGA2\_TC013032 [Tribolium castaneum]  
  
 comp1714\_c0\_seq1 PREDICTED: cyclin-A2-like [Acyrtosiphon pisum]  
 comp10676\_c0\_seq1 PREDICTED: ras association domain-containing protein 8-like [Acyrtosiphon pisum]  
 comp3775\_c0\_seq3 hypothetical protein SINV\_04875 [Solenopsis invicta]  
 comp1088\_c0\_seq1 PREDICTED: similar to AGAP009694-PA [Tribolium castaneum] gi|270001410|gb|EEZ97857.1| hypothetical protein TcasGA2\_TC000229 [Tribolium castaneum]  
  
 comp6985\_c0\_seq1 GD19864 [Drosophila simulans] gi|194198282|gb|EDX11858.1| GD19864 [Drosophila simulans]

comp4924\_c0\_seq1 PREDICTED: protein kibra-like isoform 1 [Acyrtosiphon pisum]

comp3745\_c0\_seq1 PREDICTED: similar to protein transport protein sec23 [Tribolium castaneum] gi|270009872|gb|EFA06320.1| hypothetical protein TcasGA2\_TC009191 [Tribolium castaneum]

comp7448\_c0\_seq1 PREDICTED: nucleolar complex protein 4 homolog B-like isoform 1 [Bombus terrestris]

comp7770\_c0\_seq1 hypothetical protein SINV\_04879 [Solenopsis invicta]

comp6913\_c0\_seq1 G-protein signaling modulator, putative [Pediculus humanus corporis] gi|212514168|gb|EEB16534.1| G-protein signaling modulator, putative [Pediculus humanus corporis]

comp8099\_c0\_seq1 PREDICTED: charged multivesicular body protein 6-like [Bombus terrestris]

comp3236\_c0\_seq1 PREDICTED: LOW QUALITY PROTEIN: regulator of chromosome condensation-like [Bombus terrestris]

comp10971\_c0\_seq2 PREDICTED: neurogenic locus Notch protein [Apis mellifera]

comp7593\_c0\_seq1 PREDICTED: hypothetical protein LOC100575146 isoform 1 [Acyrtosiphon pisum] gi|328719833|ref|XP\_003246874.1| PREDICTED: hypothetical protein LOC100575146 isoform 2 [Acyrtosiphon pisum] &gt;gi|328719835|ref|XP\_003246875.1| PREDICTED: hypothetical protein LOC100575146 isoform 3 [Acyrtosiphon pisum]

comp9158\_c0\_seq1 PREDICTED: similar to AGAP003463-PA [Tribolium castaneum]

comp4122\_c0\_seq1 Endoplasmic reticulum protein ERp29, putative [Pediculus humanus corporis] gi|212510717|gb|EEB13839.1| Endoplasmic reticulum protein ERp29, putative [Pediculus humanus corporis]

comp1984\_c1\_seq2 PREDICTED: similar to sumo ligase [Tribolium castaneum] gi|270010268|gb|EFA06716.1| hypothetical protein TcasGA2\_TC009647 [Tribolium castaneum]

comp4106\_c0\_seq1 COP9 signalosome complex subunit, putative [Pediculus humanus corporis] gi|212506760|gb|EEB10874.1| COP9 signalosome complex subunit, putative [Pediculus humanus corporis]

comp12735\_c0\_seq1 PREDICTED: UVRAG-like protein-like [Bombus terrestris]

comp1593\_c0\_seq1 PREDICTED: similar to proteasome beta-subunit [Nasonia vitripennis]

comp5682\_c0\_seq1 DNA-directed RNA polymerases I, II, and III 17.1 kDa polypeptide, putative [Pediculus humanus corporis] gi|212508897|gb|EEB12451.1| DNA-directed RNA polymerases I, II, and III 17.1 kDa polypeptide, putative [Pediculus humanus corporis]

comp3764\_c0\_seq1 Ribosome production factor 1 [Lepeophtheirus salmonis]

comp9348\_c0\_seq1 hypothetical protein BRAFLDRAFT\_283981 [Branchiostoma floridae] gi|229299324|gb|EEN69943.1| hypothetical protein BRAFLDRAFT\_283981 [Branchiostoma floridae]

comp11431\_c0\_seq1 PREDICTED: endoplasmic reticulum metalloproteinase 1-like [Acyrtosiphon pisum]

comp6674\_c0\_seq1 GPI transamidase component PIG-T [Acromyrmex echinator]

comp4501\_c0\_seq1 glucose dehydrogenase precursor, putative [Pediculus humanus corporis] gi|212514701|gb|EEB16960.1| glucose dehydrogenase precursor, putative [Pediculus humanus corporis]

comp6781\_c0\_seq1 RNA polymerase II subunit 7 [Nasonia vitripennis]

comp1038\_c0\_seq1 hypothetical protein Phum\_PHUM300620 [Pediculus humanus corporis] gi|212511472|gb|EEB14447.1| hypothetical protein Phum\_PHUM300620 [Pediculus humanus corporis]

comp6152\_c0\_seq1 PREDICTED: CTP synthase-like [Apis mellifera]

comp6397\_c0\_seq1 PREDICTED: hypothetical protein LOC725211 [Apis mellifera]

comp6673\_c0\_seq1 PREDICTED: similar to coiled-coil domain containing 134 [Tribolium castaneum] gi|270005764|gb|EFA02212.1| hypothetical protein TcasGA2\_TC007871 [Tribolium castaneum]

comp1109\_c0\_seq1 Importin subunit beta-1 [Harpegnathos saltator]

comp6880\_c0\_seq1

comp3456\_c0\_seq1 PREDICTED: similar to ENSANGP00000013045 [Nasonia vitripennis]

comp3856\_c0\_seq1 PREDICTED: cryptochrome-1-like [Acyrtosiphon pisum]

comp5058\_c0\_seq1 PREDICTED: e3 ubiquitin ligase RNF4-like [Monodelphis domestica]

comp2670\_c0\_seq1 Thymidylate kinase, putative [Aedes aegypti] gi|108883432|gb|EAT47657.1| Thymidylate kinase, putative [Aedes aegypti]

comp3660\_c0\_seq1 PREDICTED: similar to nonsense-mediated mrna decay protein [Tribolium castaneum] gi|270000793|gb|EEZ97240.1| hypothetical protein TcasGA2\_TC011038 [Tribolium castaneum]

comp1630\_c0\_seq1 PREDICTED: similar to ebna2 binding protein P100 [Tribolium castaneum] gi|270003672|gb|EFA00120.1| hypothetical protein TcasGA2\_TC002936 [Tribolium castaneum]

comp3885\_c0\_seq1 hypothetical protein SINV\_15235 [Solenopsis invicta]

comp4056\_c0\_seq1

comp11983\_c0\_seq1 PREDICTED: replication factor C subunit 5-like [Acyrtosiphon pisum]

comp4632\_c0\_seq1 PREDICTED: similar to GA19430-PA [Nasonia vitripennis]

comp216\_c0\_seq1 PREDICTED: similar to ribosomal protein L3e [Tribolium castaneum] gi|270011378|gb|EFA07826.1| hypothetical protein TcasGA2\_TC005395 [Tribolium castaneum]

comp8165\_c0\_seq1 parafibromin, putative [Pediculus humanus corporis] gi|212512456|gb|EEB15219.1| parafibromin, putative [Pediculus humanus corporis]

comp3400\_c0\_seq1

comp6224\_c0\_seq1 PREDICTED: similar to CG6697 CG6697-PA [Tribolium castaneum]

comp996\_c0\_seq1 PREDICTED: LOW QUALITY PROTEIN: eukaryotic translation initiation factor 3 subunit C-like [Bombus terrestris]

comp4286\_c0\_seq1 COP9 signalosome complex subunit 7A, putative [Pediculus humanus corporis] gi|212517618|gb|EEB19483.1| COP9 signalosome complex subunit 7A, putative [Pediculus humanus corporis]

comp6415\_c0\_seq1 PREDICTED: cyclic AMP response element-binding protein A-like [Acyrtosiphon pisum]

comp1799\_c0\_seq1 PREDICTED: similar to maintenance of killer 16 (mak16) protein [Nasonia vitripennis]

comp3024\_c0\_seq1 conserved hypothetical protein [Pediculus humanus corporis] gi|212508123|gb|EEB11911.1| conserved hypothetical protein [Pediculus humanus corporis]

comp2029\_c0\_seq1 PREDICTED: kinesin 8 [Apis mellifera]

comp11363\_c0\_seq1 PREDICTED: similar to beta-tubulin cofactor D [Tribolium castaneum] gi|270000809|gb|EEZ97256.1| hypothetical protein TcasGA2\_TC011056 [Tribolium castaneum]

comp3537\_c0\_seq1 PREDICTED: prenylcysteine oxidase-like [Acyrtosiphon pisum]

comp5013\_c0\_seq1 hypothetical protein SINV\_09004 [Solenopsis invicta]

comp10032\_c0\_seq1 PREDICTED: similar to CG1597 CG1597-PA [Tribolium castaneum] gi|270001063|gb|EEZ97510.1| hypothetical protein TcasGA2\_TC011354 [Tribolium castaneum]

comp5969\_c0\_seq1 hypothetical protein LOC100168418 [Acyrtosiphon pisum] gi|239791114|dbj|BAH72068.1| ACYPI009121 [Acyrtosiphon pisum]

comp240\_c0\_seq1 putative ribosomal protein S23e [Graphocephala atropunctata]

comp2052\_c0\_seq1 PREDICTED: similar to aspartate aminotransferase [Nasonia vitripennis]

comp5216\_c0\_seq1 PREDICTED: similar to LD13710p [Nasonia vitripennis]

comp5895\_c0\_seq1 PREDICTED: similar to zinc binding dehydrogenase [Tribolium castaneum] gi|270012629|gb|EFA09077.1| hypothetical protein TcasGA2\_TC006794 [Tribolium castaneum]

comp5603\_c0\_seq1 PREDICTED: similar to synaptobrevin [Tribolium castaneum] gi|270006153|gb|EFA02601.1| hypothetical protein TcasGA2\_TC008320 [Tribolium castaneum]

comp2037\_c0\_seq1 GK20976 [Drosophila willistoni] gi|194157667|gb|EDW72568.1| GK20976 [Drosophila willistoni]

comp1013\_c0\_seq1 PREDICTED: ornithine aminotransferase, mitochondrial-like isoform 1 [Acyrtosiphon pisum] gi|328701505|ref|XP\_003241621.1| PREDICTED: ornithine aminotransferase, mitochondrial-like isoform 2 [Acyrtosiphon pisum] &gt;gi|328701507|ref|XP\_003241622.1| PREDICTED: ornithine aminotransferase, mitochondrial-like isoform 3 [Acyrtosiphon pisum]

comp7637\_c0\_seq1 AGAP007923-PA [Anopheles gambiae str. PEST] gi|157015130|gb|EDO63606.1| AGAP007923-PA [Anopheles gambiae str. PEST]

comp12435\_c0\_seq1 Homeobox protein SIX4 [Acromyrmex echinator]

comp7664\_c0\_seq1 PREDICTED: uncharacterized protein C19orf29-like isoform 1 [Bombus terrestris] gi|340713931|ref|XP\_003395487.1| PREDICTED: uncharacterized protein C19orf29-like isoform 2 [Bombus terrestris]

comp1578\_c0\_seq1 PREDICTED: similar to CG3760 CG3760-PB [Tribolium castaneum] gi|270009679|gb|EFA06127.1| hypothetical protein TcasGA2\_TC008970 [Tribolium castaneum]

comp1312\_c0\_seq1 clathrin heavy chain, putative [Pediculus humanus corporis] gi|212507343|gb|EEB11299.1| clathrin heavy chain, putative [Pediculus humanus corporis]

comp5780\_c0\_seq1 dihydrofolate reductase [Drosophila melanogaster]

comp4944\_c0\_seq1 hypothetical protein AaeL\_AAEL006270 [Aedes aegypti] gi|108877937|gb|EAT42162.1| conserved hypothetical protein [Aedes aegypti]

comp5388\_c0\_seq1

comp4841\_c0\_seq1 PREDICTED: furin-like protease 1, isoform 1-CRR-like [Acyrtosiphon pisum]

comp1473\_c0\_seq1 alkaline phosphatase 1 [Nilaparvata lugens]

comp263\_c0\_seq1 PREDICTED: similar to calcyclin binding protein [Tribolium castaneum] gi|270017125|gb|EFA13571.1| hypothetical protein TcasGA2\_TC010306 [Tribolium castaneum]

comp998\_c0\_seq1 translocon-associated protein subunit delta precursor, putative [Pediculus humanus corporis] gi|212517119|gb|EEB19056.1| translocon-associated protein subunit delta precursor, putative [Pediculus humanus corporis]

comp273\_c0\_seq2 putative ubiquitin/ribosomal protein S27Ae fusion protein [Oncopeltus fasciatus]

comp105\_c0\_seq4 hypothetical protein AND\_07297 [Anopheles darlingi]

comp9440\_c0\_seq1 PREDICTED: similar to kelch repeat protein isoform 1 [Tribolium castaneum] gi|270003222|gb|EEZ99669.1| hypothetical protein TcasGA2\_TC002426 [Tribolium castaneum]

comp2134\_c1\_seq1 conserved hypothetical protein [Culex quinquefasciatus] gi|167872918|gb|EDS36301.1| conserved hypothetical protein [Culex quinquefasciatus]

comp3583\_c0\_seq1 hypothetical protein AND\_02129 [Anopheles darlingi]

comp2358\_c0\_seq1 AGAP008604-PA [Anopheles gambiae str. PEST] gi|157016660|gb|EAL40245.2| AGAP008604-PA [Anopheles gambiae str. PEST]

comp9276\_c0\_seq1 Protein arginine N-methyltransferase 5 [Harpegnathos saltator]

comp4160\_c0\_seq1 AGAP007242-PA [Anopheles gambiae str. PEST] gi|116132312|gb|EAA04203.3| AGAP007242-PA [Anopheles gambiae str. PEST]

comp7797\_c0\_seq1 PREDICTED: vacuolar protein sorting-associated protein 13B-like [Acyrtosiphon pisum]

comp3636\_c0\_seq1 PREDICTED: tuberin [Apis mellifera]

comp9833\_c0\_seq1 PREDICTED: zinc finger protein 99-like [Acyrtosiphon pisum]

comp8341\_c0\_seq1 PREDICTED: mediator of RNA polymerase II transcription subunit 17 [Apis mellifera]

comp799\_c0\_seq1 hypothetical protein LOC100161110 [Acyrtosiphon pisum] gi|239799277|dbj|BAH70567.1| ACYPI002360 [Acyrtosiphon pisum]

comp11709\_c0\_seq1 Nucleoporin Ndc1, putative [Pediculus humanus corporis] gi|212516737|gb|EEB18711.1| Nucleoporin Ndc1, putative [Pediculus humanus corporis]

comp4706\_c0\_seq1 Spermine synthase [Camponotus floridanus]

comp1275\_c0\_seq1 hypothetical protein SINV\_16053 [Solenopsis invicta]

comp2047\_c0\_seq1 Wiskott-Aldrich syndrome protein family member 3 [Harpegnathos saltator]

comp1384\_c0\_seq1 60 kDa heat shock protein, mitochondrial [Acromyrmex echinator]

comp4986\_c0\_seq2 PREDICTED: spermatogenesis-associated protein 5-like [Apis mellifera]

comp5537\_c0\_seq2 PREDICTED: LOW QUALITY PROTEIN: actin-binding protein anillin [Apis mellifera]

comp3448\_c0\_seq1 PREDICTED: similar to AGAP003542-PA [Tribolium castaneum]

gi|270002217|gb|EEZ98664.1| hypothetical protein TcasGA2\_TC001195 [Tribolium castaneum]

comp1812\_c0\_seq1 PREDICTED: similar to LD23157p [Nasonia vitripennis]

comp381\_c0\_seq1 vitellogenin-2 [Plautia stali]

comp283\_c0\_seq1 PREDICTED: maternal protein exuperantia-like [Bombus terrestris]

comp2485\_c0\_seq2 cyclin B [Nasonia vitripennis]

rudimentary-like [Drosophila melanogaster]

gi|76800654|sp|Q01637.2|PYR5\_DROME RecName: Full=Uridine 5'&#x2013;monophosphate synthase; Short=UMP synthase; AltName: Full=Rudimentary-like protein; Includes: RecName: Full=Orotate phosphoribosyltransferase; Short=OPRTase; Includes: RecName: Full=Orotidine 5'&#x2013;phosphate decarboxylase; AltName: Full=OMPdecase &#x26;#x27;gi|7300695|gb|AAF55842.1| rudimentary-like [Drosophila melanogaster] &#x26;#x27;gi|16198241|gb|AAL13943.1| LD45235p [Drosophila melanogaster] &#x26;#x27;gi|220946406|gb|ACL85746.1| r-l-PA [synthetic construct] &#x26;#x27;gi|220956092|gb|ACL90589.1| r-l-PA [synthetic construct]

comp4718\_c0\_seq1

comp8512\_c1\_seq1 PREDICTED: protein FAM122A-like [Bombus terrestris]

comp3189\_c0\_seq1 PREDICTED: CWF19-like protein 2-like [Acyrtosiphon pisum]

comp2177\_c0\_seq1

comp1511\_c0\_seq1 minifly protein, putative [Pediculus humanus corporis]

gi|212515248|gb|EEB17419.1| minifly protein, putative [Pediculus humanus corporis]

comp2655\_c0\_seq1 PREDICTED: collagen alpha-1(IV) chain-like isoform 1 [Acyrtosiphon pisum] gi|328723517|ref|XP\_003247862.1|

comp2655\_c0\_seq1 PREDICTED: collagen alpha-1(IV) chain-like isoform 2 [Acyrtosiphon pisum]

comp2561\_c0\_seq1 PREDICTED: similar to Noa36 CG10009-PA [Tribolium castaneum]

gi|270005496|gb|EFA01944.1| hypothetical protein TcasGA2\_TC007558 [Tribolium castaneum]

comp4185\_c0\_seq2 PREDICTED: zinc finger protein 131-like [Acyrtosiphon pisum]

comp3842\_c0\_seq1 YjeF domain-containing protein, putative [Pediculus humanus corporis] gi|212510140|gb|EEB13365.1| YjeF domain-containing protein, putative [Pediculus humanus corporis]

comp10407\_c0\_seq2 conserved hypothetical protein [Pediculus humanus corporis] gi|212517234|gb|EEB19155.1| conserved hypothetical protein [Pediculus humanus corporis]

comp4312\_c0\_seq2 helicase with zinc finger protein domain helz, putative [Pediculus humanus corporis] gi|212508927|gb|EEB12468.1| helicase with zinc finger protein domain helz, putative [Pediculus humanus corporis]

comp3949\_c0\_seq1 conserved hypothetical protein [Pediculus humanus corporis] gi|212510047|gb|EEB13299.1| conserved hypothetical protein [Pediculus humanus corporis]

comp1763\_c0\_seq2 possible SD repeat-containing cell surface protein precursor [Pediococcus acidilactici DSM 20284] gi|304328006|gb|EFL95229.1| possible SD repeat-containing cell surface protein precursor [Pediococcus acidilactici DSM 20284]

comp12860\_c0\_seq1 Integrator complex subunit 12 [Harpegnathos saltator]

comp1888\_c0\_seq2 PREDICTED: similar to AGAP002077-PA [Tribolium castaneum]

comp3231\_c0\_seq1 PREDICTED: pontin protein isoform 1 [Apis mellifera]

comp634\_c2\_seq11 PREDICTED: tRNA pseudouridine synthase-like 1-like [Acyrtosiphon pisum]

comp4371\_c0\_seq1 GJ21580 [Drosophila virilis] gi|194144233|gb|EDW60629.1| GJ21580 [Drosophila virilis]

comp11237\_c0\_seq2 conserved hypothetical protein [Pediculus humanus corporis] gi|212513701|gb|EEB16172.1| conserved hypothetical protein [Pediculus humanus corporis]

comp7153\_c0\_seq1 PREDICTED: similar to GA11371-PA [Tribolium castaneum]

comp4807\_c0\_seq1 PREDICTED: exosome complex component MTR3-like [Bombus terrestris]

comp4949\_c0\_seq1 PREDICTED: puromycin-sensitive aminopeptidase-like [Acyrtosiphon pisum]

comp5574\_c0\_seq1

comp3259\_c0\_seq1

comp8555\_c0\_seq1 serine/threonine-protein phosphatase 6 catalytic subunit [Acyrtosiphon pisum] gi|239790702|dbj|BAH71896.1| ACYPI010064 [Acyrtosiphon pisum]

comp1965\_c0\_seq1 PREDICTED: importin-4-like [Apis mellifera]

comp2428\_c1\_seq1 Isoleucyl-tRNA synthetase, cytoplasmic [Harpegnathos saltator]

comp2592\_c0\_seq1 hypothetical protein SINV\_10425 [Solenopsis invicta]

comp4742\_c0\_seq1 Nuclear pore complex protein Nup93, putative [Pediculus humanus corporis] gi|212517883|gb|EEB19712.1| Nuclear pore complex protein Nup93, putative [Pediculus humanus corporis]

comp3994\_c0\_seq1 PREDICTED: similar to conserved hypothetical protein [Nasonia vitripennis]

comp5998\_c0\_seq1 Membrane-associated protein Hem [Acromyrmex echinator]

comp11113\_c0\_seq1 PREDICTED: zinc finger protein 91-like [Acyrtosiphon pisum]

comp4115\_c0\_seq1 PREDICTED: similar to ubiquitin fusion degradaton protein [Nasonia vitripennis]

comp7479\_c0\_seq1 Zinc finger protein ush [Harpegnathos saltator]

comp8939\_c0\_seq1 PREDICTED: sphingomyelin synthase-related 1-like [Bombus terrestris]

comp8499\_c0\_seq1 PREDICTED: LOW QUALITY PROTEIN: kinetochore-associated protein 1-like [Bombus terrestris]

comp4243\_c0\_seq2 COP9 signalosome complex subunit, putative [Pediculus humanus corporis] gi|212515414|gb|EEB17561.1| COP9 signalosome complex subunit, putative [Pediculus humanus corporis]



comp4969\_c0\_seq1 Inosine triphosphate pyrophosphatase, putative [Pediculus humanus corporis] gi|212515181|gb|EEB17362.1| Inosine triphosphate pyrophosphatase, putative [Pediculus humanus corporis]

comp6242\_c0\_seq2 PREDICTED: similar to AGAP002284-PA [Tribolium castaneum] gi|270006047|gb|EFA02495.1| hypothetical protein TcasGA2\_TC008190 [Tribolium castaneum]

comp4748\_c0\_seq1 l-asparaginase i [Aedes aegypti] gi|108881762|gb|EAT45987.1| l-asparaginase i [Aedes aegypti]

comp5533\_c0\_seq2 PREDICTED: hypothetical protein LOC100649743 [Bombus terrestris]

comp484\_c0\_seq1 gamma-interferon-inducible lysosomal thiol reductase precursor, putative [Pediculus humanus corporis] gi|212518703|gb|EEB20424.1| gamma-interferon-inducible lysosomal thiol reductase precursor, putative [Pediculus humanus corporis]

comp470\_c0\_seq1

comp3059\_c0\_seq1 Transforming acidic coiled-coil-containing protein 1 [Camponotus floridanus]

comp6724\_c0\_seq1 PREDICTED: hypothetical protein LOC100162750 isoform 1 [Acyrtosiphon pisum]

comp7991\_c0\_seq1 Ankyrin repeat and LEM domain-containing protein 2 [Harpegnathos saltator]

comp2611\_c0\_seq1 PREDICTED: hypothetical protein LOC100159253 isoform 1 [Acyrtosiphon pisum] gi|328716903|ref|XP\_003246070.1| PREDICTED: hypothetical protein LOC100159253 isoform 2 [Acyrtosiphon pisum]

comp2486\_c0\_seq1 hypothetical protein Aasi\_1441 [Candidatus Amoebophilus asiaticus 5a2] gi|189498184|gb|ACE06731.1| hypothetical protein Aasi\_1441 [Candidatus Amoebophilus asiaticus 5a2]

comp7837\_c0\_seq1 PREDICTED: protein RSM22 homolog, mitochondrial-like [Acyrtosiphon pisum]

comp4832\_c0\_seq4 PREDICTED: hypothetical protein LOC725889 [Apis mellifera]

comp5894\_c0\_seq1 PREDICTED: similar to ATP-dependent transporter [Tribolium castaneum] gi|270013337|gb|EFA09785.1| hypothetical protein TcasGA2\_TC011927 [Tribolium castaneum]

comp7999\_c0\_seq1 PREDICTED: similar to niemann-pick C1 [Tribolium castaneum]

comp8049\_c0\_seq1 AGAP003417-PA [Anopheles gambiae str. PEST]

comp5586\_c0\_seq1 PREDICTED: SWI/SNF-related matrix-associated actin-dependent regulator of chromatin subfamily B member 1-like [Bombus terrestris]

comp4316\_c0\_seq1 PREDICTED: actin-interacting protein 1-like isoform 2 [Acyrtosiphon pisum]

comp1702\_c0\_seq1 PREDICTED: similar to AGAP009119-PA [Tribolium castaneum] gi|270014189|gb|EFA10637.1| hypothetical protein TcasGA2\_TC016274 [Tribolium castaneum]

comp9547\_c0\_seq1 Sorting nexin-13, putative [Pediculus humanus corporis] gi|212516139|gb|EEB18183.1| Sorting nexin-13, putative [Pediculus humanus corporis]

comp3324\_c0\_seq1 PREDICTED: pre-rRNA-processing protein TSR1 homolog [Apis mellifera]

comp4708\_c0\_seq1 hypothetical protein Phum\_PHUM163860 [Pediculus humanus corporis] gi|212508546|gb|EEB12194.1| hypothetical protein Phum\_PHUM163860 [Pediculus humanus corporis]

comp8468\_c0\_seq1 Protein farnesyltransferase/geranylgeranyltransferase type-1 subunit alpha [Acromyrmex echinatior]

comp4224\_c0\_seq1

comp3023\_c0\_seq1 Threonyl-tRNA synthetase, cytoplasmic, putative [Pediculus humanus corporis] gi|212518045|gb|EEB19847.1| Threonyl-tRNA synthetase, cytoplasmic, putative [Pediculus humanus corporis]

comp3804\_c0\_seq2 PREDICTED: similar to predicted protein [Tribolium castaneum] gi|270008010|gb|EFA04458.1| hypothetical protein TcasGA2\_TC014762 [Tribolium castaneum]

comp124\_c0\_seq1 vitellogenin-3 [Plautia stali]

comp4569\_c0\_seq1 Augmenter of liver regeneration, putative [Pediculus humanus corporis] gi|212516556|gb|EEB18550.1| Augmenter of liver regeneration, putative [Pediculus humanus corporis]

comp1987\_c0\_seq1 PREDICTED: similar to CG3983 CG3983-PB [Tribolium castaneum] gi|270014031|gb|EFA10479.1| hypothetical protein TcasGA2\_TC012725 [Tribolium castaneum]

comp3531\_c0\_seq1 PREDICTED: similar to conserved hypothetical protein [Nasonia vitripennis]

comp12\_c0\_seq1 vitellogenin [Lethocerus deyrollei]

comp40\_c0\_seq1 vitellogenin [Trigonotylus caelestialium]

comp5539\_c0\_seq1 Cullin-4B [Harpegnathos saltator]

comp3089\_c0\_seq1 hypothetical protein DAPPUDRAFT\_306646 [Daphnia pulex]

comp2161\_c0\_seq1 Splicing factor U2Af 38 kDa subunit, putative [Pediculus humanus corporis] gi|212512324|gb|EEB15117.1| Splicing factor U2Af 38 kDa subunit, putative [Pediculus humanus corporis]

comp1851\_c0\_seq1 PREDICTED: similar to LD34072p [Nasonia vitripennis]

comp4781\_c0\_seq1 conserved hypothetical protein [Pediculus humanus corporis] gi|212516013|gb|EEB18072.1| conserved hypothetical protein [Pediculus humanus corporis]

comp3880\_c0\_seq1 syntaxin, putative [Aedes aegypti] gi|108879064|gb|EAT43289.1| syntaxin, putative [Aedes aegypti]

comp3222\_c0\_seq1 hypothetical protein SINV\_05415 [Solenopsis invicta]

comp4595\_c0\_seq2 Signal recognition particle 72 kDa protein, putative [Pediculus humanus corporis] gi|212516466|gb|EEB18479.1| Signal recognition particle 72 kDa protein, putative [Pediculus humanus corporis]

comp6304\_c0\_seq1 PREDICTED: histone demethylase UTY-like, partial [Apis mellifera]

comp3423\_c0\_seq1 protein C20orf11, putative [Pediculus humanus corporis] gi|212508104|gb|EEB11900.1| protein C20orf11, putative [Pediculus humanus corporis]

comp7538\_c0\_seq1 tRNA-dihydrouridine synthase, putative [Pediculus humanus corporis] gi|212505672|gb|EEB10076.1| tRNA-dihydrouridine synthase, putative [Pediculus humanus corporis]

comp7808\_c0\_seq1 PREDICTED: u2 snRNP-associated SURP motif-containing protein-like [Apis mellifera]

comp4846\_c0\_seq1 PREDICTED: zinc finger protein 729-like [Danio rerio]  
 comp12057\_c0\_seq1 PREDICTED: hypothetical protein [Strongylocentrotus purpuratus]  
 comp3765\_c0\_seq4 dorsal protein isoform A [Apis mellifera] gi|30351106|gb|AAP23055.1| dorsal protein [Apis mellifera]  
 comp7269\_c0\_seq1 PREDICTED: hypothetical protein LOC100166610 [Acyrtosiphon pisum]  
 comp1869\_c0\_seq1 guanine nucleotide-binding protein subunit beta-like [Microplitis mediator]  
 comp6003\_c0\_seq1 PREDICTED: similar to eIF2B-alpha protein [Nasonia vitripennis]  
 comp3696\_c0\_seq1 conserved hypothetical protein [Pediculus humanus corporis] gi|212508785|gb|EEB12373.1| conserved hypothetical protein [Pediculus humanus corporis]  
 comp3228\_c0\_seq1 PREDICTED: similar to signal peptidase complex subunit 3 [Tribolium castaneum] gi|270005949|gb|EFA02397.1| hypothetical protein TcasGA2\_TC008077 [Tribolium castaneum]  
 comp3249\_c0\_seq1 oxidase, putative [Talaromyces stipitatus ATCC 10500] gi|218718404|gb|EED17824.1| oxidase, putative [Talaromyces stipitatus ATCC 10500]  
 comp7480\_c0\_seq1 aaa atpase [Aedes aegypti] gi|108874664|gb|EAT38889.1| aaa atpase [Aedes aegypti]  
 comp7528\_c0\_seq1 PREDICTED: hypothetical protein LOC100643403 [Bombus terrestris]  
 comp3106\_c0\_seq1 PREDICTED: probable ATP-dependent RNA helicase DDX23-like [Bombus terrestris]  
 comp5228\_c0\_seq1 hypothetical protein TcasGA2\_TC010759 [Tribolium castaneum]  
 comp6969\_c0\_seq1 CCR4-NOT transcription complex subunit 3 [Camponotus floridanus]  
 comp7361\_c0\_seq1 PREDICTED: similar to myb-like, SWIRM and MPN domains 1 [Tribolium castaneum] gi|270013339|gb|EFA09787.1| hypothetical protein TcasGA2\_TC011929 [Tribolium castaneum]  
 comp8101\_c0\_seq1 PREDICTED: similar to CG7371 CG7371-PA [Tribolium castaneum] gi|270006960|gb|EFA03408.1| hypothetical protein TcasGA2\_TC013395 [Tribolium castaneum]  
 comp2525\_c0\_seq2 GK11710 [Drosophila willistoni] gi|194165871|gb|EDW80772.1| GK11710 [Drosophila willistoni]  
 comp1414\_c0\_seq1 PREDICTED: hypothetical protein LOC551973 [Apis mellifera]  
 comp909\_c0\_seq1 Unknown protein [Arabidopsis thaliana]  
 comp904\_c0\_seq1 PREDICTED: limkain-b1-like isoform 1 [Acyrtosiphon pisum]  
 comp482\_c1\_seq1 histone H2B.3, putative [Pediculus humanus corporis] gi|212516129|gb|EEB18173.1| histone H2B.3, putative [Pediculus humanus corporis]  
 comp4891\_c0\_seq1 PREDICTED: WD and tetratricopeptide repeats protein 1-like [Apis mellifera]  
 comp1785\_c0\_seq1 PREDICTED: hypothetical protein [Nasonia vitripennis]  
 comp1547\_c0\_seq1 Importin-7 [Camponotus floridanus]  
 comp6157\_c0\_seq1 Pterin-4-alpha-carbinolamine dehydratase 2 [Camponotus floridanus]

comp7391\_c0\_seq1 hypothetical protein Phum\_PHUM521410 [Pediculus humanus corporis] gi|212516591|gb|EEB18585.1| hypothetical protein Phum\_PHUM521410 [Pediculus humanus corporis]

comp2635\_c1\_seq1 hypothetical protein Aael\_AAEL005528 [Aedes aegypti] gi|108878769|gb|EAT42994.1| conserved hypothetical protein [Aedes aegypti]

comp3053\_c0\_seq1 conserved hypothetical protein [Pediculus humanus corporis] gi|212516481|gb|EEB18494.1| conserved hypothetical protein [Pediculus humanus corporis]

comp7288\_c0\_seq1 PREDICTED: lysosomal thioesterase PPT2 homolog isoform 2 [Apis mellifera]

comp3664\_c0\_seq1 Bromodomain-containing protein, putative [Pediculus humanus corporis] gi|212508638|gb|EEB12271.1| Bromodomain-containing protein, putative [Pediculus humanus corporis]

comp9959\_c0\_seq1 PREDICTED: protein downstream neighbor of son homolog [Acyrtosiphon pisum]

comp7312\_c0\_seq1 PREDICTED: similar to lethal (1) G0431 CG14788-PA [Tribolium castaneum] gi|270007374|gb|EFA03822.1| hypothetical protein TcasGA2\_TC013937 [Tribolium castaneum]

comp7924\_c0\_seq1 Nuclear transcription factor Y subunit gamma [Camponotus floridanus]

comp1287\_c0\_seq1

comp6388\_c0\_seq1 PREDICTED: hypothetical protein LOC100163939 [Acyrtosiphon pisum]

comp11361\_c0\_seq1 PREDICTED: similar to AGAP008858-PA [Tribolium castaneum] gi|270006798|gb|EFA03246.1| hypothetical protein TcasGA2\_TC013179 [Tribolium castaneum]

comp1842\_c0\_seq3 PREDICTED: similar to CG10354 CG10354-PA [Tribolium castaneum]

comp9705\_c0\_seq1 PREDICTED: mothers against decapentaplegic homolog 6-like [Acyrtosiphon pisum]

comp4117\_c0\_seq1 conserved hypothetical protein [Pediculus humanus corporis] gi|212517283|gb|EEB19194.1| conserved hypothetical protein [Pediculus humanus corporis]

comp7899\_c0\_seq1 PREDICTED: integrator complex subunit 9-like [Bombus terrestris]

comp6577\_c0\_seq1 PREDICTED: similar to pcdc2/rp-8 (programmed cell death protein 2) [Nasonia vitripennis]

comp7740\_c0\_seq1 PREDICTED: transcription initiation factor TFIID subunit 2-like [Bombus terrestris]

comp3693\_c0\_seq1 PREDICTED: integrator complex subunit 11-like [Bombus terrestris]

comp8979\_c0\_seq1 Univin precursor, putative [Pediculus humanus corporis] gi|212508300|gb|EEB12039.1| Univin precursor, putative [Pediculus humanus corporis]

comp8272\_c0\_seq2 AGAP001236-PA [Anopheles gambiae str. PEST]

comp1684\_c0\_seq1 T-complex protein 1 subunit zeta [Acromyrmex echinatior]

comp3480\_c0\_seq1

comp165\_c0\_seq1 putative ribosomal protein L32 [Maconellicoccus hirsutus]

comp5716\_c0\_seq1 PREDICTED: ras-related protein Rab-32-like [Bombus terrestris]

comp3736\_c0\_seq6 inhibitor of growth protein 3 [Apis mellifera]

comp1421\_c0\_seq1 hypothetical protein DAPPUDRAFT\_191687 [Daphnia pulex]

comp8426\_c0\_seq1 PREDICTED: diphosphomevalonate decarboxylase-like [Bombus terrestris]

comp4764\_c0\_seq1 Apoptosis inhibitor, putative [Pediculus humanus corporis]  
gi|212506438|gb|EEB10656.1| Apoptosis inhibitor, putative [Pediculus humanus corporis]

comp3269\_c0\_seq1 PREDICTED: similar to LOC100049152 protein [Nasonia vitripennis]

comp2788\_c0\_seq1 Obg-like ATPase 1 [Acyrtosiphon pisum]  
gi|239788262|dbj|BAH70819.1| ACYPI52009 [Acyrtosiphon pisum]  
&gt;gi|239788264|dbj|BAH70820.1| ACYPI52009 [Acyrtosiphon pisum]  
&gt;gi|239788266|dbj|BAH70821.1| ACYPI52009 [Acyrtosiphon pisum]  
&gt;gi|239788268|dbj|BAH70822.1| ACYPI52009 [Acyrtosiphon pisum]  
&gt;gi|239788270|dbj|BAH70823.1| ACYPI52009 [Acyrtosiphon pisum]  
&gt;gi|239788272|dbj|BAH70824.1| ACYPI52009 [Acyrtosiphon pisum]

comp204\_c1\_seq1 ribosomal protein L15e [Georissus sp. APV-2005]

comp746\_c0\_seq1 PREDICTED: similar to AGAP010331-PA [Tribolium castaneum]

comp2224\_c0\_seq2 PREDICTED: lysyl-tRNA synthetase-like isoform 3 [Acyrtosiphon pisum]

comp10854\_c0\_seq1 hypothetical protein TcasGA2\_TC005383 [Tribolium castaneum]

comp1777\_c0\_seq1 PREDICTED: ubiquitin domain-containing protein 1-like [Acyrtosiphon pisum]

comp4792\_c0\_seq1 PREDICTED: similar to fidipidine [Tribolium castaneum]

comp7365\_c0\_seq1 PREDICTED: uncharacterized protein KIAA0528-like [Bombus terrestris]

comp9131\_c0\_seq1 sugar transporter 2 [Nilaparvata lugens]

comp5407\_c0\_seq1 PREDICTED: probable N(2),N(2)-dimethylguanosine tRNA methyltransferase-like isoform 1 [Acyrtosiphon pisum]

comp835\_c0\_seq1 GF11304 [Drosophila ananassae] gi|190622133|gb|EDV37657.1|  
GF11304 [Drosophila ananassae]

comp6\_c0\_seq1 vitellogenin [Athalia rosae]

comp4342\_c0\_seq1 GE20182 [Drosophila yakuba] gi|194180578|gb|EDW94189.1|  
GE20182 [Drosophila yakuba]

comp9984\_c0\_seq1 conserved hypothetical protein [Culex quinquefasciatus]  
gi|167867040|gb|EDS30423.1| conserved hypothetical protein [Culex quinquefasciatus]

comp6817\_c0\_seq1 Transmembrane protein 203 [Acromyrmex echinator]

comp1092\_c0\_seq2 ribosomal protein L10Ae [Cicindela littoralis]

comp350\_c0\_seq1 90 kDa heat shock protein [Bemisia tabaci]

comp6601\_c0\_seq1 PREDICTED: glyoxylate reductase/hydroxypyruvate reductase-like isoform 1 [Acyrtosiphon pisum] gi|328704005|ref|XP\_003242374.1|  
PREDICTED: glyoxylate reductase/hydroxypyruvate reductase-like isoform 2 [Acyrtosiphon pisum]

comp9124\_c0\_seq1 PREDICTED: hypothetical protein LOC100166285 [Acyrtosiphon pisum]

comp2416\_c0\_seq4 28S ribosomal protein S9, mitochondrial [Culex quinquefasciatus] gi|167870808|gb|EDS34191.1| 28S ribosomal protein S9, mitochondrial [Culex quinquefasciatus]

comp7132\_c0\_seq1 PREDICTED: similar to reserved [Tribolium castaneum]

comp2025\_c0\_seq1 PREDICTED: similar to small nuclear ribonucleoprotein at 69D CG10753-PA [Tribolium castaneum] gi|270016480|gb|EFA12926.1| hypothetical protein TcasGA2\_TC010472 [Tribolium castaneum]

comp1403\_c0\_seq1 proliferating cell nuclear antigen [Litopenaeus vannamei] gi|339721489|gb|AEJ89928.1| proliferating cell nuclear antigen [Litopenaeus vannamei]

comp3226\_c0\_seq1 PREDICTED: similar to alcohol dehydrogenase [Nasonia vitripennis]

comp5686\_c0\_seq1 phosphatidylethanolamine-binding protein-like [Acyrtosiphon pisum] gi|239789027|dbj|BAH71163.1| ACYPI002878 [Acyrtosiphon pisum]

comp5637\_c0\_seq1 PREDICTED: la-related protein 7-like [Apis mellifera]

comp3958\_c0\_seq2 PREDICTED: protein transport protein Sec24C-like [Apis mellifera]

comp2713\_c0\_seq1 PREDICTED: mitochondrial import inner membrane translocase subunit TIM44-like isoform 1 [Apis mellifera]

comp6477\_c0\_seq1 E3 ubiquitin ligase triad3, putative [Pediculus humanus corporis] gi|212516216|gb|EEB18254.1| E3 ubiquitin ligase triad3, putative [Pediculus humanus corporis]

comp3369\_c0\_seq2 GK24233 [Drosophila willistoni] gi|194163131|gb|EDW78032.1| GK24233 [Drosophila willistoni]

comp4364\_c0\_seq1 COMPASS component SWD2, putative [Pediculus humanus corporis] gi|212510446|gb|EEB13631.1| COMPASS component SWD2, putative [Pediculus humanus corporis]

comp4665\_c0\_seq1 Probable ubiquitin carboxyl-terminal hydrolase FAF-X [Camponotus floridanus]

comp1818\_c0\_seq1 PREDICTED: similar to ubiquitin-activating enzyme E1 [Tribolium castaneum]

comp3198\_c0\_seq1 hypothetical protein TcasGA2\_TC009771 [Tribolium castaneum]

comp2860\_c0\_seq1 PREDICTED: similar to 28S ribosomal protein S5 [Tribolium castaneum] gi|270010452|gb|EFA06900.1| hypothetical protein TcasGA2\_TC009847 [Tribolium castaneum]

comp2694\_c0\_seq1 PREDICTED: similar to conserved hypothetical protein [Nasonia vitripennis]

comp1685\_c0\_seq1 PREDICTED: serine/threonine-protein kinase Nek7-like [Meleagris gallopavo]

comp1373\_c0\_seq1 PREDICTED: serine/threonine-protein kinase polo-like [Acyrtosiphon pisum]

comp3372\_c0\_seq1 PREDICTED: similar to protein disulfide isomerase [Nasonia vitripennis]

comp2267\_c0\_seq2

comp4490\_c0\_seq1 PREDICTED: fatty acid 2-hydroxylase-like [Acyrtosiphon pisum]

comp2324\_c0\_seq1 hypothetical protein TcasGA2\_TC002488 [Tribolium castaneum]

comp6516\_c0\_seq1 PREDICTED: similar to histone deacetylase [Tribolium castaneum] gi|270003320|gb|EEZ99767.1| hypothetical protein TcasGA2\_TC002540 [Tribolium castaneum]

comp2048\_c0\_seq1 PREDICTED: similar to carbamoyl-phosphate synthase large chain [Tribolium castaneum] gi|270013749|gb|EFA10197.1| hypothetical protein TcasGA2\_TC012392 [Tribolium castaneum]

comp5622\_c0\_seq3 DEAD-box helicase Dbp80 [Harpegnathos saltator]

comp4770\_c0\_seq2 PREDICTED: exportin-5-like [Bombus terrestris]

comp4349\_c0\_seq1 hypothetical protein G5I\_04322 [Acromyrmex echinator]

comp5263\_c0\_seq1 Breast cancer metastasis-suppressor, putative [Pediculus humanus corporis] gi|212511208|gb|EEB14241.1| Breast cancer metastasis-suppressor, putative [Pediculus humanus corporis]

comp1490\_c0\_seq1 follicle cell protein 3C [Blattella germanica]

comp1096\_c0\_seq1 Eukaryotic translation initiation factor 4E [Harpegnathos saltator]

comp4813\_c0\_seq1

comp5300\_c0\_seq1 PREDICTED: lysine-specific demethylase NO66-like [Bombus terrestris]

comp3718\_c0\_seq1 conserved hypothetical protein [Pediculus humanus corporis] gi|212514728|gb|EEB16984.1| conserved hypothetical protein [Pediculus humanus corporis]

comp2439\_c0\_seq1 PREDICTED: DNA replication licensing factor mcm7-like isoform 1 [Acyrtosiphon pisum] gi|328710702|ref|XP\_003244337.1| PREDICTED: DNA replication licensing factor mcm7-like isoform 2 [Acyrtosiphon pisum]

comp4439\_c0\_seq1 PREDICTED: Hermansky-Pudlak syndrome 1 protein homolog [Acyrtosiphon pisum]

comp12473\_c0\_seq1 zinc finger protein, putative [Pediculus humanus corporis] gi|212518778|gb|EEB20499.1| zinc finger protein, putative [Pediculus humanus corporis]

comp926\_c0\_seq1 PREDICTED: similar to conserved hypothetical protein [Tribolium castaneum] gi|270007441|gb|EFA03889.1| hypothetical protein TcasGA2\_TC014013 [Tribolium castaneum]

comp7548\_c0\_seq1 PREDICTED: similar to serine/threonine-protein kinase RIO1 [Tribolium castaneum] gi|270005675|gb|EFA02123.1| hypothetical protein TcasGA2\_TC007772 [Tribolium castaneum]

comp1456\_c0\_seq1 DNA topoisomerase 1 [Camponotus floridanus]

comp4555\_c0\_seq1 DNA methyltransferase 1-associated protein 1 [Harpegnathos saltator]

comp9818\_c0\_seq1 coiled-coil domain-containing protein, putative [Pediculus humanus corporis] gi|212515961|gb|EEB18026.1| coiled-coil domain-containing protein, putative [Pediculus humanus corporis]

comp2001\_c0\_seq1 Tripeptidyl-peptidase 2 [Harpegnathos saltator]

comp8140\_c0\_seq1 PREDICTED: similar to CG12701 CG12701-PA [Tribolium castaneum] gi|270008254|gb|EFA04702.1| vielfaltig [Tribolium castaneum]

comp2936\_c0\_seq1 AGAP006818-PA [Anopheles gambiae str. PEST] gi|157020637|gb|EAA04227.4| AGAP006818-PA [Anopheles gambiae str. PEST]

comp9274\_c0\_seq1 PREDICTED: SWI/SNF-related matrix-associated actin-dependent regulator of chromatin subfamily A-like protein 1-like [Acyrtosiphon pisum]

comp1367\_c0\_seq1 hypothetical protein SINV\_01813 [Solenopsis invicta]

comp7622\_c0\_seq2  
 comp7869\_c0\_seq1 B lymphoma Mo-MLV insertion region 1b [Danio rerio]  
 comp1955\_c0\_seq1 ACYPI007188 [Acyrtosiphon pisum]  
 comp5399\_c0\_seq1 Large neutral amino acids transporter small subunit 2 [Acromyrmex echinator]  
 PREDICTED: hypothetical protein LOC100573509 isoform 1  
 comp3932\_c1\_seq1 [Acyrtosiphon pisum] gi|328708857|ref|XP\_003243817.1|  
 PREDICTED: hypothetical protein LOC100573509 isoform 2  
 [Acyrtosiphon pisum]  
 GA27162 [Drosophila pseudoobscura pseudoobscura]  
 comp509\_c0\_seq1 gi|198131635|gb|EDY67919.1| GA27162 [Drosophila pseudoobscura pseudoobscura]  
 comp2504\_c0\_seq1 PREDICTED: gametogenetin-binding protein 2-like [Apis mellifera]  
 comp5992\_c0\_seq1 PREDICTED: hypothetical protein LOC100638831 [Amphimedon queenslandica]  
 hypothetical protein AaeL\_AAEL010837 [Aedes aegypti]  
 comp2440\_c0\_seq1 gi|108872915|gb|EAT37140.1| conserved hypothetical protein [Aedes aegypti]  
 comp6340\_c0\_seq1 PREDICTED: mitogen-activated protein kinase kinase kinase 9-like [Acyrtosiphon pisum]  
 comp9970\_c0\_seq1 hypothetical protein [Ictalurus punctatus]  
 comp8609\_c0\_seq1 GK12822 [Drosophila willistoni] gi|194170119|gb|EDW85020.1|  
 GK12822 [Drosophila willistoni]  
 comp9333\_c0\_seq1 PREDICTED: similar to CG8311-PA [Nasonia vitripennis]  
 comp6462\_c0\_seq1 AGAP001319-PA [Anopheles gambiae str. PEST]  
 comp1688\_c0\_seq1 hypothetical protein TcasGA2\_TC004080 [Tribolium castaneum]  
 comp9321\_c0\_seq1 cytochrome P450 [Bemisia tabaci]  
 comp1773\_c1\_seq1 PREDICTED: solute carrier family 35 member B1 homolog [Acyrtosiphon pisum]  
 comp1537\_c0\_seq1 PREDICTED: tRNA (uracil-5-)-methyltransferase homolog A-like [Acyrtosiphon pisum]  
 comp5084\_c0\_seq1  
 comp6764\_c0\_seq2 hypothetical protein LOC100163911 [Acyrtosiphon pisum]  
 gi|239792500|dbj|BAH72586.1| ACYPI004962 [Acyrtosiphon pisum]  
 comp8715\_c0\_seq1 PREDICTED: CD109 antigen-like [Acyrtosiphon pisum]  
 comp1091\_c0\_seq1 PREDICTED: stress-induced-phosphoprotein 1-like [Acyrtosiphon pisum]  
 comp867\_c0\_seq1 PREDICTED: tubulin beta chain-like [Amphimedon queenslandica]  
 comp1677\_c0\_seq7 Prefoldin subunit 6 [Acromyrmex echinator]  
 phosphatidylethanolamine-binding protein [Aedes aegypti]  
 comp4210\_c0\_seq1 gi|108870917|gb|EAT35142.1| phosphatidylethanolamine-binding protein [Aedes aegypti]  
 comp1241\_c0\_seq1 PREDICTED: t-complex protein 1 subunit gamma-like isoform 1 [Bombus terrestris]  
 comp3592\_c0\_seq1  
 comp783\_c0\_seq1 PREDICTED: similar to diacylglycerol o-acyltransferase [Nasonia vitripennis]  
 comp7073\_c0\_seq1 PREDICTED: hypothetical protein LOC100649269 [Bombus terrestris]  
 comp11561\_c0\_seq2 hypothetical protein TcasGA2\_TC014427 [Tribolium castaneum]



comp5200\_c0\_seq2 elongation factor ts [Aedes aegypti]  
 gi|122069482|sp|Q17PI0.1|EFTS\_AEDAE RecName: Full=Elongation factor Ts, mitochondrial; Short=EF-Ts; Short=EF-TsMt; Flags: Precursor &gt;gi|108884412|gb|EAT48637.1| elongation factor ts [Aedes aegypti]

comp1229\_c0\_seq1 glycosyl-phosphatidyl-inositol-anchored protein [Bombyx mori]  
 gi|87248139|gb|ABD36122.1| glycosyl-phosphatidyl-inositol-anchored protein [Bombyx mori]

comp4301\_c0\_seq1 WD repeat-containing protein 4 [Camponotus floridanus]

comp42\_c0\_seq1 putative pterin-4-alpha-carbinolamine dehydratase [Diaphorina citri]

comp4215\_c0\_seq1 PREDICTED: phenoloxidase subunit A3-like [Acyrtosiphon pisum]

comp828\_c0\_seq1 GJ20513 [Drosophila virilis] gi|194144659|gb|EDW61055.1| GJ20513 [Drosophila virilis]

comp3186\_c0\_seq1 PREDICTED: leucyl-tRNA synthetase, cytoplasmic-like isoform 1 [Apis mellifera]

comp6887\_c0\_seq1 conserved hypothetical protein [Pediculus humanus corporis]  
 gi|212507728|gb|EEB11590.1| conserved hypothetical protein [Pediculus humanus corporis]

comp1009\_c0\_seq1 PREDICTED: f-box only protein 28-like [Apis mellifera]

comp5538\_c0\_seq1 AGAP009600-PA [Anopheles gambiae str. PEST]  
 gi|157013889|gb|EAA14456.4| AGAP009600-PA [Anopheles gambiae str. PEST]

comp4088\_c0\_seq1 conserved hypothetical protein [Pediculus humanus corporis]  
 gi|212509059|gb|EEB12556.1| conserved hypothetical protein [Pediculus humanus corporis]

comp7272\_c0\_seq1 hypothetical protein TcasGA2\_TC009925 [Tribolium castaneum]

comp4234\_c0\_seq1 hypothetical protein TcasGA2\_TC005972 [Tribolium castaneum]

comp1127\_c0\_seq1 hypothetical protein Phum\_PHUM405430 [Pediculus humanus corporis] gi|212513603|gb|EEB16122.1| hypothetical protein Phum\_PHUM405430 [Pediculus humanus corporis]

comp5123\_c0\_seq1 PREDICTED: similar to golgi phosphoprotein 3 (coat-protein GPP34) [Tribolium castaneum] gi|270014486|gb|EFA10934.1| hypothetical protein TcasGA2\_TC001762 [Tribolium castaneum]

comp7840\_c0\_seq1 PREDICTED: exocyst complex component 6B-like isoform 2 [Bombus terrestris]

comp2862\_c0\_seq2 PREDICTED: u3 small nucleolar RNA-associated protein 14 homolog A-like [Apis mellifera]

comp6698\_c0\_seq1 hypothetical protein SINV\_05401 [Solenopsis invicta]

comp3264\_c0\_seq1 Transcription elongation factor SPT5 [Camponotus floridanus]

comp4777\_c0\_seq1 PREDICTED: similar to ENSANGP00000014283 [Nasonia vitripennis]

comp2016\_c0\_seq3 PERQ amino acid-rich with GYF domain-containing protein 2 [Harpegnathos saltator]

comp8631\_c0\_seq1 PREDICTED: protein deltex [Apis mellifera]

comp9297\_c0\_seq1

comp2340\_c0\_seq1 PREDICTED: similar to proteasome alpha 4 subunit [Nasonia vitripennis]

comp9750\_c0\_seq1 conserved hypothetical protein [Pediculus humanus corporis]  
gi|212511663|gb|EEB14580.1| conserved hypothetical protein  
[Pediculus humanus corporis]  
GA28568 [Drosophila pseudoobscura pseudoobscura]

comp12510\_c0\_seq1 gi|198151215|gb|EDY74106.1| GA28568 [Drosophila pseudoobscura  
pseudoobscura]

comp3519\_c0\_seq1 PREDICTED: hypothetical protein LOC100163498 isoform 2  
[Acyrtosiphon pisum]

comp2684\_c0\_seq1 PREDICTED: pentatricopeptide repeat-containing protein 2-like  
[Acyrtosiphon pisum]

comp3132\_c0\_seq1 translation elongation factor G [Halomonas sp. TD01]  
gi|338764053|gb|EGP19030.1| translation elongation factor G  
[Halomonas sp. TD01]

comp768\_c0\_seq1 PREDICTED: prolow-density lipoprotein receptor-related protein 1-like  
[Acyrtosiphon pisum]

comp563\_c0\_seq1 PREDICTED: importin subunit alpha-2-like [Bombus terrestris]

## Table S2 Annotation of male-biased genes

Assembly ID	NR database
comp1796_c0_seq1	GG21229 [Drosophila erecta] gi 190651643 gb EDV48898.1  GG21229 [Drosophila erecta]
comp8162_c0_seq2	hypothetical protein EAI_14722 [Harpegnathos saltator]
comp2863_c0_seq1	sugar transporter 7 [Nilaparvata lugens]
comp10931_c0_seq1	PREDICTED: JNK-interacting protein 1-like [Acyrthosiphon pisum]
comp72_c0_seq1	OS-D-like protein [Maconellicoccus hirsutus]
comp1098_c0_seq2	PREDICTED: similar to Zinc carboxypeptidase family protein [Tribolium castaneum]
comp4187_c0_seq1	
comp5819_c0_seq1	nicotinic acetylcholine receptor [Ctenocephalides felis]
comp5741_c0_seq1	PREDICTED: similar to CG3955-PA [Nasonia vitripennis]
comp6313_c0_seq2	
comp1380_c0_seq4	
comp68_c0_seq4	PREDICTED: myosin heavy chain, muscle isoform 1 [Acyrthosiphon pisum]
comp1964_c0_seq1	
comp743_c0_seq1	PREDICTED: hypothetical protein [Tribolium castaneum]
comp1130_c0_seq1	PREDICTED: sarcalumenin-like [Apis mellifera]
comp636_c0_seq1	PREDICTED: neurogenic locus notch homolog protein 1-like [Acyrthosiphon pisum]
comp9455_c0_seq4	PREDICTED: hypothetical protein LOC100650591 [Bombus terrestris]
comp1010_c0_seq1	
comp634_c2_seq1	hypothetical protein TcasGA2_TC009181 [Tribolium castaneum]
comp3944_c0_seq1	
comp2801_c0_seq1	RecName: Full=Hypertrehalosaemic prohormone; Contains: RecName: Full=Hypertrehalosaemic hormone; Short=HTH; AltName: Full=Hypertrehalosaemic neuropeptide; Contains: RecName: Full=Hypertrehalosaemic hormone precursor-related peptide; Flags: Precursor gi 1022716 gb AAA79691.1  prepro-hypertrehalosemic hormone [Blaberus discoidalis]
comp1432_c0_seq1	
comp997_c0_seq1	
comp8888_c0_seq1	PREDICTED: hypothetical protein LOC100572071 [Acyrthosiphon
comp6912_c0_seq2	PREDICTED: hypothetical protein LOC100159668 [Acyrthosiphon
comp172_c0_seq1	
comp9334_c0_seq1	PREDICTED: similar to CG13375 CG13375-PA [Tribolium castaneum]
comp6702_c0_seq1	PREDICTED: similar to RAS-like, family 10, member B [Tribolium castaneum] gi 270008592 gb EFA05040.1  hypothetical protein TcasGA2_TC015129 [Tribolium castaneum]
comp3545_c0_seq2	hypothetical protein SINV_03318 [Solenopsis invicta]
comp2174_c0_seq1	chemosensory protein-like [Acyrthosiphon pisum]
comp992_c0_seq1	gi 77415640 emb CAJ01489.1  hypothetical protein [Acyrthosiphon pisum]
comp705_c0_seq1	PREDICTED: carbonic anhydrase 7-like [Acyrthosiphon pisum]
comp3725_c0_seq6	Arrestin-like protein [Camponotus floridanus]
comp7367_c0_seq1	cardioactive peptide isoform B [Rhodnius prolixus]
comp3840_c0_seq1	hypothetical protein TcasGA2_TC010074 [Tribolium castaneum]

comp5403\_c0\_seq1 PREDICTED: synaptic vesicular amine transporter-like isoform 2 [Acyrtosiphon pisum] gi|328709290|ref|XP\_001945866.2|  
 PREDICTED: synaptic vesicular amine transporter-like isoform 1 [Acyrtosiphon pisum]

comp7465\_c0\_seq1 hypothetical protein CAEBREN\_13576 [Caenorhabditis brenneri]

comp149\_c0\_seq1  
 comp388\_c0\_seq1  
 comp706\_c0\_seq1 cysteine proteinase [Hypera postica]

comp2287\_c0\_seq2 AGAP005124-PC [Anopheles gambiae str. PEST] gi|157017072|gb|EAA09458.5| AGAP005124-PC [Anopheles gambiae str. PEST]

comp678\_c0\_seq1  
 comp23\_c0\_seq1 secreted cathepsin F [Teladorsagia circumcincta]

comp8575\_c0\_seq1 hypothetical protein TcasGA2\_TC003629 [Tribolium castaneum]

comp3102\_c0\_seq1 TPA: putative cuticle protein [Bombyx mori]

comp763\_c0\_seq1  
 comp9143\_c0\_seq1 hypothetical protein TcasGA2\_TC011452 [Tribolium castaneum]

comp758\_c1\_seq9  
 comp185\_c0\_seq1  
 comp464\_c0\_seq1

comp3163\_c0\_seq1 PREDICTED: hypothetical protein LOC100568861 [Acyrtosiphon]

comp13092\_c0\_seq1 PREDICTED: hypothetical protein LOC100577239 [Apis mellifera]

comp5477\_c0\_seq1 cytochrome P450 [Bemisia tabaci]

comp1104\_c0\_seq1 PREDICTED: alpha-tocopherol transfer protein-like [Bombus terrestris]

comp3540\_c0\_seq1 PREDICTED: hypothetical protein LOC100575897 isoform 1 [Acyrtosiphon pisum] gi|328698904|ref|XP\_003240765.1|  
 PREDICTED: hypothetical protein LOC100575897 isoform 2

comp9603\_c0\_seq1 hypothetical protein TcasGA2\_TC001759 [Tribolium castaneum]

comp5821\_c0\_seq1 AChE2 [Bemisia tabaci] gi|157366848|gb|ABV45415.1| AChE2 [Bemisia tabaci]

comp913\_c0\_seq1 cathepsin L-like proteinase [Diabrotica virgifera virgifera]

comp1331\_c5\_seq3

comp8517\_c0\_seq1 hypothetical protein Phum\_PHUM258430 [Pediculus humanus corporis] gi|212510658|gb|EEB13794.1| hypothetical protein Phum\_PHUM258430 [Pediculus humanus corporis]

comp5029\_c0\_seq1 PREDICTED: glycine receptor subunit beta-type 4-like [Acyrtosiphon pisum]

comp7526\_c0\_seq3 chitin binding peritrophin-A, putative [Pediculus humanus corporis] gi|212514415|gb|EEB16743.1| chitin binding peritrophin-A, putative [Pediculus humanus corporis]

comp4999\_c1\_seq1 AChE1 [Bemisia tabaci]

comp26\_c0\_seq1 myosin 3 light chain [Lonomia obliqua]

comp4400\_c0\_seq1 PREDICTED: hypothetical protein LOC100166909 [Acyrtosiphon]

comp11\_c0\_seq3

comp2334\_c0\_seq1 conserved hypothetical protein [Pediculus humanus corporis] gi|212506420|gb|EEB10638.1| conserved hypothetical protein [Pediculus humanus corporis]

comp5042\_c0\_seq3 PREDICTED: sodium- and chloride-dependent creatine transporter 1-like isoform 1 [Acyrtosiphon pisum] gi|328714515|ref|XP\_003245380.1| PREDICTED: sodium- and chloride-dependent creatine transporter 1-like isoform 2 [Acyrtosiphon]

comp1000\_c0\_seq2  
 comp2955\_c0\_seq1 PREDICTED: hypothetical protein LOC100570172 [Acyrtosiphon]

comp467\_c0\_seq1

comp1544\_c0\_seq1 cuticular protein 58 [Acyrtosiphon pisum] gi|328710782|ref|XP\_003244356.1| PREDICTED: hypothetical protein LOC100573511 [Acyrtosiphon pisum]  
 &gt;gi|239792554|dbj|BAH72607.1| ACYPI003073 [Acyrtosiphon  
 comp7388\_c0\_seq1 PREDICTED: hypothetical protein LOC100569264 [Acyrtosiphon  
 comp5240\_c0\_seq1 PREDICTED: similar to GA20722-PA [Tribolium castaneum]  
 comp4590\_c0\_seq1  
 comp8703\_c0\_seq1 dual specificity protein phosphatase, putative [Pediculus humanus corporis] gi|212511054|gb|EEB14103.1| dual specificity protein phosphatase, putative [Pediculus humanus corporis]  
 comp2004\_c0\_seq1 PREDICTED: hypothetical protein LOC100160882 [Acyrtosiphon  
 comp1497\_c0\_seq1  
 comp986\_c0\_seq1 hypothetical protein TcasGA2\_TC010484 [Tribolium castaneum]  
 comp9234\_c0\_seq1  
 comp634\_c2\_seq9 PREDICTED: hypothetical protein LOC100167699 [Acyrtosiphon rab3 interacting molecule, putative [Pediculus humanus corporis] gi|212515720|gb|EEB17818.1| rab3 interacting molecule, putative [Pediculus humanus corporis]  
 comp7085\_c0\_seq1  
 comp1468\_c0\_seq2 Muscle M-line assembly protein unc-89 [Harpegnathos saltator]  
 comp7421\_c0\_seq1 PREDICTED: hypothetical protein LOC100163311 [Acyrtosiphon conserved hypothetical protein [Pediculus humanus corporis] gi|212516800|gb|EEB18768.1| conserved hypothetical protein [Pediculus humanus corporis]  
 comp820\_c0\_seq1  
 comp4890\_c0\_seq1  
 comp423\_c0\_seq1 PREDICTED: similar to peroxiredoxin [Nasonia vitripennis]  
 comp5082\_c0\_seq1 PREDICTED: similar to CG11044 CG11044-PA [Tribolium castaneum]  
 comp2949\_c1\_seq1 carboxylesterase [Laodelphax striatellus] gi|313667164|gb|ADR73025.1| carboxylesterase [Laodelphax Glutamate decarboxylase [Camponotus floridanus]  
 comp2564\_c0\_seq1  
 comp1936\_c0\_seq6  
 comp1055\_c0\_seq1 PREDICTED: hypothetical protein LOC100573041 [Acyrtosiphon  
 comp9943\_c0\_seq1  
 comp43\_c0\_seq1  
 comp257\_c0\_seq1 PREDICTED: glucose dehydrogenase [acceptor]-like [Acyrtosiphon pisum]  
 comp77\_c6\_seq83  
 comp1383\_c0\_seq1 PREDICTED: hypothetical protein LOC100165870 [Acyrtosiphon UGA suppressor tRNA-associated protein, putative [Pediculus humanus corporis] gi|212509888|gb|EEB13174.1| UGA suppressor tRNA-associated protein, putative [Pediculus humanus corporis]  
 comp5532\_c0\_seq2  
 comp3294\_c0\_seq1 allatostatin A prohormone precursor [Gryllus bimaculatus]  
 comp487\_c0\_seq3 L-xylulose reductase [Anoplopoma fimbria]  
 comp2445\_c0\_seq1 death-associated small cytoplasmic leucine-rich protein [Bombyx mori] gi|221579656|gb|ACM24345.1| death-associated small cytoplasmic leucine-rich protein [Bombyx mori]  
 comp7035\_c0\_seq1 PREDICTED: similar to DopEcR CG18314-PA [Tribolium castaneum] gi|270012800|gb|EFA09248.1| hypothetical protein TcasGA2\_TC006457 [Tribolium castaneum]  
 comp988\_c0\_seq1 PREDICTED: prohormone-1-like [Bombus terrestris]  
 comp9062\_c0\_seq1 protein phosphatase-7 [Aedes aegypti] gi|108881203|gb|EAT45428.1| protein phosphatase-7 [Aedes aegypti]  
 comp1146\_c0\_seq2 leucomyosuppressin precursor [Blattella germanica]  
 comp4273\_c1\_seq1

comp4398\_c0\_seq1 conserved hypothetical protein [Culex quinquefasciatus] gi|167882481|gb|EDS45864.1| conserved hypothetical protein [Culex quinquefasciatus]  
 comp3141\_c0\_seq1 PREDICTED: similar to papilin [Tribolium castaneum]  
 comp2265\_c0\_seq1 PREDICTED: trimeric intracellular cation channel type B-like [Apis mellifera]  
 comp7058\_c0\_seq1 RAB 3 and, putative [Pediculus humanus corporis] gi|212506265|gb|EEB10525.1| RAB 3 and, putative [Pediculus humanus corporis]  
 comp1095\_c0\_seq1 odorant binding protein 6 [Apolygus lucorum]  
 comp5120\_c0\_seq1  
 comp1767\_c0\_seq1 hypothetical protein TcasGA2\_TC000669 [Tribolium castaneum]  
 comp80\_c0\_seq1  
 comp823\_c0\_seq3 hypothetical protein TcasGA2\_TC011220 [Tribolium castaneum]  
 comp1837\_c0\_seq1 pathogenesis related gene 5 [Bupleurum kaoi]  
 comp7683\_c0\_seq1 PREDICTED: transmembrane and TPR repeat-containing protein 1-like [Bombus terrestris]  
 comp886\_c0\_seq1 hypothetical protein TcasGA2\_TC008620 [Tribolium castaneum]  
 comp4045\_c0\_seq1 sodium channel, auxiliary protein, putative [Aedes aegypti] gi|108882513|gb|EAT46738.1| sodium channel, auxiliary protein, putative [Aedes aegypti]  
 comp4451\_c0\_seq2 Tubulin-specific chaperone cofactor E-like protein [Harpegnathos saltator]  
 comp7499\_c0\_seq1 PREDICTED: hypothetical protein LOC100574750 isoform 1 [Acyrtosiphon pisum] gi|328700245|ref|XP\_003241194.1| PREDICTED: hypothetical protein LOC100574750 isoform 2  
 comp1841\_c0\_seq1  
 comp1464\_c0\_seq1  
 comp529\_c0\_seq1  
 comp32\_c0\_seq1  
 comp863\_c0\_seq1  
 comp5879\_c0\_seq1  
 comp3882\_c0\_seq1  
 comp932\_c0\_seq1  
 comp10069\_c0\_seq1 PREDICTED: hypothetical protein LOC100651767 [Bombus terrestris]  
 comp1274\_c0\_seq1 troponin C-like [Acyrtosiphon pisum] gi|239793671|dbj|BAH72939.1| ACYPI007505 [Acyrtosiphon pisum]  
 comp1418\_c0\_seq1 PREDICTED: facilitated trehalose transporter Tret1-like [Acyrtosiphon pisum]  
 comp4217\_c0\_seq2  
 comp1566\_c0\_seq1  
 comp4055\_c0\_seq1 PREDICTED: similar to IP17045p [Nasonia vitripennis]  
 comp10881\_c0\_seq1 PREDICTED: allatostatin-A receptor-like [Acyrtosiphon pisum]  
 comp4179\_c0\_seq1  
 comp2810\_c0\_seq1 PREDICTED: putative fatty acyl-CoA reductase CG5065-like [Acyrtosiphon pisum]  
 comp466\_c0\_seq1  
 comp7143\_c0\_seq1 PREDICTED: similar to conserved hypothetical protein [Tribolium castaneum] gi|270011903|gb|EFA08351.1| hypothetical protein TcasGA2\_TC005994 [Tribolium castaneum]  
 comp1320\_c0\_seq1  
 comp235\_c0\_seq2  
 comp4311\_c0\_seq1 PREDICTED: hypothetical protein LOC100167736 [Acyrtosiphon]  
 comp10708\_c0\_seq1 PREDICTED: similar to CG34351 CG34351-PC [Tribolium castaneum]

comp581\_c0\_seq1 PREDICTED: similar to conserved hypothetical protein [Tribolium castaneum] gi|270010967|gb|EFA07415.1| brain peptide ITGQGNRIF-like protein [Tribolium castaneum]

comp2305\_c0\_seq1 PREDICTED: hypothetical protein LOC100165710 [Acyrtosiphon

comp6279\_c0\_seq1 blue-sensitive opsin precursor [Dianemobius nigrofasciatus]

comp9957\_c0\_seq2 PREDICTED: hypothetical protein LOC100572072 [Acyrtosiphon

comp7826\_c0\_seq1 hypothetical protein TcasGA2\_TC015574 [Tribolium castaneum]

comp1805\_c0\_seq1

comp1394\_c0\_seq1 PREDICTED: probable maltase L-like [Acyrtosiphon pisum]

comp10637\_c0\_seq1 PREDICTED: similar to high-affinity serotonin transporter [Tribolium castaneum] gi|270016267|gb|EFA12713.1| hypothetical protein TcasGA2\_TC002347 [Tribolium castaneum]

comp1555\_c0\_seq1 hypothetical protein TcasGA2\_TC003200 [Tribolium castaneum]

comp3792\_c0\_seq1

comp3068\_c0\_seq2 f-spondin [Aedes aegypti] gi|108876156|gb|EAT40381.1| f-spondin [Aedes aegypti]

comp248\_c0\_seq1 mitochondrial F1F0-ATP synthase subunit delta/ATP16 [Cimex lectularius]

comp1721\_c0\_seq1 ADP-ribose pyrophosphatase, mitochondrial [Camponotus floridanus]

comp5662\_c0\_seq1

comp772\_c0\_seq2 PREDICTED: alpha-crystallin B chain-like isoform 3 [Acyrtosiphon pisum]

myofilin isoform b [Acyrtosiphon pisum]

comp110\_c0\_seq1 gi|253735725|ref|NP\_001156710.1| myofilin isoform b [Acyrtosiphon pisum] >gi|239793567|dbj|BAH72895.1| ACYPI002609 [Acyrtosiphon pisum]

comp1082\_c0\_seq1

comp1124\_c0\_seq1

comp1953\_c0\_seq1

comp319\_c0\_seq1

comp1790\_c0\_seq1 G112142 [Drosophila mojavensis] gi|193919466|gb|EDW18333.1| G112142 [Drosophila mojavensis]

comp5612\_c0\_seq1 odorant-binding protein 5 [Metopolophium dirhodum]

comp7159\_c0\_seq1

comp6983\_c0\_seq1 PREDICTED: hypothetical protein LOC100650488 [Bombus terrestris]

comp144\_c0\_seq1

comp2637\_c0\_seq1 PREDICTED: opsin, ultraviolet-sensitive-like [Acyrtosiphon pisum]

comp363\_c0\_seq1

comp1046\_c0\_seq1

comp3237\_c0\_seq3 Dopamine beta-hydroxylase precursor, putative [Pediculus humanus corporis] gi|212509498|gb|EEB12867.1| Dopamine beta-hydroxylase precursor, putative [Pediculus humanus corporis]

comp2370\_c0\_seq1 PREDICTED: short neuropeptide F-like isoform 1 [Acyrtosiphon pisum] gi|328721243|ref|XP\_003247251.1| PREDICTED: short neuropeptide F-like isoform 2 [Acyrtosiphon pisum]

comp8100\_c0\_seq1 PREDICTED: hypothetical protein LOC100160452 [Acyrtosiphon

comp3054\_c0\_seq1 putative rhodopsin [Oncometopia nigricans]

comp3077\_c0\_seq1

comp4388\_c0\_seq1 PREDICTED: similar to CG6329-PB [Nasonia vitripennis]

comp6798\_c0\_seq1 PREDICTED: similar to CG12541 CG12541-PB [Tribolium castaneum] gi|270014059|gb|EFA10507.1| hypothetical protein TcasGA2\_TC012755 [Tribolium castaneum]

comp317\_c0\_seq3 GA27408 [Drosophila pseudoobscura pseudoobscura] gi|198132577|gb|EDY68326.1| GA27408 [Drosophila pseudoobscura pseudoobscura]  
 comp1549\_c0\_seq1 PREDICTED: BTB/POZ domain-containing protein KCTD16-like [Bombus terrestris]  
 comp1661\_c0\_seq1 cytochrome B5 [Culicoides sonorensis]  
 comp1507\_c0\_seq1 GF21209 [Drosophila ananassae] gi|190618724|gb|EDV34248.1| GF21209 [Drosophila ananassae]  
 comp1326\_c0\_seq1 hypothetical protein EAG\_09069 [Camponotus floridanus]  
 comp2391\_c0\_seq1 PREDICTED: PQ-loop repeat-containing protein 1-like [Acyrtosiphon pisum]  
 comp2090\_c0\_seq1 arylalkylamine N-acetyltransferase-like [Acyrtosiphon pisum] gi|239788497|dbj|BAH70924.1| ACYPI002543 [Acyrtosiphon pisum]  
 comp3063\_c1\_seq1 cuticular protein [Tenebrio molitor]  
 comp3034\_c0\_seq3 PREDICTED: synapse-associated protein of 47 kDa-like isoform 2 [Acyrtosiphon pisum]  
 comp7374\_c0\_seq1  
 comp2800\_c0\_seq1 PREDICTED: UDP-glucuronosyltransferase 2B14-like [Acyrtosiphon pisum]  
 comp895\_c0\_seq2 PREDICTED: similar to npdc-1 [Nasonia vitripennis]  
 comp16101\_c0\_seq2 PREDICTED: similar to CG34127 CG34127-PA [Tribolium castaneum]  
 comp2468\_c0\_seq1 PREDICTED: hypothetical protein LOC100168705 [Acyrtosiphon sodium-dependent nutrient amino acid transporter, putative [Pediculus humanus corporis] gi|212505979|gb|EEB10310.1| sodium-dependent nutrient amino acid transporter, putative [Pediculus humanus corporis]  
 comp9538\_c0\_seq1 PREDICTED: hypothetical protein LOC100573179 [Acyrtosiphon  
 comp4373\_c0\_seq1 cathepsin B-like proteinase [Triatoma vitticeps]  
 comp309\_c0\_seq1  
 comp632\_c1\_seq3  
 comp74\_c0\_seq1  
 comp3066\_c0\_seq1  
 comp7571\_c1\_seq1 stearyl-coa desaturase-like [Acyrtosiphon pisum] gi|239791638|dbj|BAH72259.1| ACYPI006757 [Acyrtosiphon pisum]  
 comp9736\_c0\_seq1  
 comp3051\_c0\_seq1  
 comp11042\_c0\_seq1 PREDICTED: similar to conserved hypothetical protein [Nasonia vitripennis]  
 comp6763\_c0\_seq1 F-box/LRR-repeat protein, putative [Pediculus humanus corporis] gi|212506146|gb|EEB10443.1| F-box/LRR-repeat protein, putative [Pediculus humanus corporis]  
 comp152\_c0\_seq1 hypothetical protein TcasGA2\_TC010476 [Tribolium castaneum]  
 comp1054\_c0\_seq1 hypothetical protein EAG\_04387 [Camponotus floridanus]  
 comp412\_c0\_seq1 troponin C-like [Acyrtosiphon pisum] gi|239790194|dbj|BAH71673.1| ACYPI007392 [Acyrtosiphon pisum]  
 comp10488\_c0\_seq1  
 comp2281\_c0\_seq2  
 comp6621\_c0\_seq1 GF24229 [Drosophila ananassae] gi|190624385|gb|EDV39909.1| GF24229 [Drosophila ananassae]  
 comp1286\_c0\_seq1  
 comp11024\_c0\_seq1 PREDICTED: hypothetical protein LOC100161072 [Acyrtosiphon  
 comp1227\_c0\_seq1  
 comp2109\_c0\_seq1



comp110\_c0\_seq3 myofilin isoform b [Acyrtosiphon pisum]  
 gi|253735725|ref|NP\_001156710.1| myofilin isoform b [Acyrtosiphon  
 pisum] &gt;gi|239793567|dbj|BAH72895.1| ACYPI002609  
 [Acyrtosiphon pisum]

comp2556\_c0\_seq1  
 comp2100\_c0\_seq1 hypothetical protein TcasGA2\_TC007091 [Tribolium castaneum]  
 comp151\_c0\_seq1 PREDICTED: hypothetical protein LOC100159632 [Acyrtosiphon  
 comp4772\_c0\_seq1  
 comp1572\_c0\_seq1 PREDICTED: similar to short-chain dehydrogenase [Nasonia  
 PREDICTED: potassium channel subfamily T member 1-like  
 comp10332\_c0\_seq2 [Acyrtosiphon pisum]

comp1430\_c0\_seq2 PREDICTED: neuroendocrine convertase 1-like [Acyrtosiphon pisum]  
 conserved hypothetical protein [Pediculus humanus corporis]

comp1349\_c0\_seq1 gi|212516655|gb|EEB18641.1| conserved hypothetical protein  
 [Pediculus humanus corporis]

comp4361\_c0\_seq1 PREDICTED: facilitated trehalose transporter Tret1-like [Acyrtosiphon  
 pisum]

comp7895\_c0\_seq1 PREDICTED: similar to CG7120 CG7120-PA [Tribolium castaneum]  
 gi|270014094|gb|EFA10542.1| hypothetical protein  
 TcasGA2\_TC012797 [Tribolium castaneum]

comp448\_c0\_seq2 hypothetical protein TcasGA2\_TC013580 [Tribolium castaneum]  
 comp3728\_c0\_seq1 PREDICTED: hypothetical protein LOC100572962 [Acyrtosiphon  
 comp1514\_c0\_seq1 hypothetical protein NEMVEDRAFT\_v1g4783 [Nematostella vectensis]  
 gi|156207529|gb|EDO29409.1| predicted protein [Nematostella

comp1756\_c0\_seq1  
 comp135\_c0\_seq1  
 comp475\_c0\_seq1

comp5841\_c0\_seq1 AGAP008442-PA [Anopheles gambiae str. PEST]  
 gi|157014809|gb|EAA12647.4| AGAP008442-PA [Anopheles gambiae  
 str. PEST]

comp5465\_c0\_seq1  
 comp2961\_c0\_seq1 hypothetical protein TcasGA2\_TC009699 [Tribolium castaneum]

comp2033\_c0\_seq10 hypothetical protein LOC678510 [Apis mellifera]  
 gi|89274060|dbj|BAE80739.1| GB15078 [Apis mellifera]

comp1065\_c0\_seq1 tachykinin precursor [Rhodnius prolixus]

comp13129\_c0\_seq1 hypothetical protein TcasGA2\_TC011555 [Tribolium castaneum]

comp665\_c0\_seq2 PREDICTED: similar to CG32171-PD [Nasonia vitripennis]  
 uridine diphosphate glucosyltransferase [Bombyx mori]

comp1509\_c0\_seq1 gi|213494483|gb|ACJ48963.1| uridine diphosphate glucosyltransferase  
 [Bombyx mori]

comp2414\_c0\_seq1 cathepsin B [Acyrtosiphon pisum]

comp1706\_c0\_seq1 salivary secreted protein [Triatoma infestans]

comp1561\_c0\_seq1 GF13563 [Drosophila ananassae] gi|190622137|gb|EDV37661.1|  
 GF13563 [Drosophila ananassae]

comp362\_c0\_seq1 conserved hypothetical protein [Pediculus humanus corporis]  
 gi|212510636|gb|EEB13772.1| conserved hypothetical protein  
 [Pediculus humanus corporis]

comp697\_c0\_seq1 PREDICTED: probable maltase H [Acyrtosiphon pisum]

conserved hypothetical protein [Pediculus humanus corporis]

comp1568\_c0\_seq7 gi|212509245|gb|EEB12690.1| conserved hypothetical protein  
 [Pediculus humanus corporis]

comp4337\_c0\_seq1 PREDICTED: hypothetical protein LOC100161965 [Acyrtosiphon  
 pisum] gi|239789069|dbj|BAH71182.1| ACYPI003149 [Acyrtosiphon

comp2170\_c0\_seq3 RecName: Full=Diuretic hormone; Short=DH; AltName: Full=Diuretic peptide; Short=DP gi|265669|gb|AAB25411.1| CRF-related diuretic peptide [Periplaneta americana=cockroaches, Peptide, 46 aa]

comp445\_c0\_seq1 PREDICTED: uncharacterized family 31 glucosidase KIAA1161-like [Acyrtosiphon pisum]

comp5210\_c0\_seq1 PREDICTED: hypothetical protein LOC100163035 [Acyrtosiphon]

comp1163\_c0\_seq1

comp444\_c0\_seq2

comp139\_c2\_seq11

comp2902\_c0\_seq3 unknown [Populus trichocarpa x Populus deltoides]

comp1804\_c0\_seq1 carbonic anhydrase II, putative [Aedes aegypti]

gi|108874595|gb|EAT38820.1| carbonic anhydrase II, putative [Aedes aegypti]

comp8079\_c0\_seq2 GE20711 [Drosophila yakuba] gi|194179610|gb|EDW93221.1|

GE20711 [Drosophila yakuba]

comp6093\_c0\_seq1

comp2957\_c0\_seq1 cuticular protein analogous to peritrophins 3-D1 [Tribolium castaneum]

gi|268309022|gb|ACY95477.1| cuticular protein analogous to peritrophins 3-D1 [Tribolium castaneum]

&gt;gi|270000884|gb|EEZ97331.1| hypothetical protein

comp1208\_c0\_seq1

comp1200\_c0\_seq1

comp2943\_c0\_seq4 hypothetical protein TcasGA2\_TC000583 [Tribolium castaneum]

comp4572\_c0\_seq1 cuticle protein-like protein [Triatoma matogrossensis]

conserved hypothetical protein [Pediculus humanus corporis]

comp5284\_c0\_seq1 gi|212518410|gb|EEB20163.1| conserved hypothetical protein [Pediculus humanus corporis]

comp5028\_c0\_seq1 angiotensin converting enzyme [Locusta migratoria]

comp1867\_c0\_seq4

comp1094\_c0\_seq1 PREDICTED: orcokinin peptides type A-like [Acyrtosiphon pisum]

comp10061\_c0\_seq2 PREDICTED: similar to cationic amino acid transporter 4 [Tribolium castaneum] gi|270012508|gb|EFA08956.1| hypothetical protein TcasGA2\_TC006663 [Tribolium castaneum]

comp68\_c0\_seq3 PREDICTED: myosin heavy chain, muscle isoform 1 [Acyrtosiphon pisum]

comp949\_c0\_seq1

comp2462\_c0\_seq1 hypothetical protein SINV\_04886 [Solenopsis invicta]

comp9147\_c0\_seq1 PREDICTED: guanine nucleotide-binding protein subunit beta-2-like [Acyrtosiphon pisum]

conserved hypothetical protein [Pediculus humanus corporis]

comp590\_c0\_seq1 gi|212518565|gb|EEB20311.1| conserved hypothetical protein [Pediculus humanus corporis]

comp325\_c0\_seq1 hypothetical protein TcasGA2\_TC004676 [Tribolium castaneum]

comp2241\_c0\_seq1 hypothetical protein SINV\_00593 [Solenopsis invicta]

comp4421\_c0\_seq1

conserved hypothetical protein [Pediculus humanus corporis]

comp1381\_c0\_seq2 gi|212507456|gb|EEB11401.1| conserved hypothetical protein [Pediculus humanus corporis]

comp3643\_c0\_seq2 PREDICTED: endoplasmic reticulum aminopeptidase 2-like [Acyrtosiphon pisum]

comp2151\_c0\_seq1

comp2419\_c0\_seq1

comp2899\_c0\_seq1

comp1247\_c0\_seq1 GH14220 [Drosophila grimshawi] gi|193891727|gb|EDV90593.1|  
GH14220 [Drosophila grimshawi]  
actin related protein 1 [Acyrtosiphon pisum]  
gi|242011914|ref|XP\_002426688.1| Actin, muscle [Pediculus humanus  
corporis] &gt;gi|46561736|gb|AAT01073.1| putative muscle actin  
[Homalodisca vitripennis] &gt;gi|52630959|gb|AAU84943.1| putative  
muscle actin [Toxoptera citricida] &gt;gi|53830696|gb|AAU95191.1|  
comp34\_c0\_seq1 putative muscle actin [Oncometopia nigricans]  
&gt;gi|77158630|gb|ABA62321.1| beta-actin [Reticulitermes flavipes]  
&gt;gi|91221295|gb|ABE27979.1| putative muscle actin [Lygus  
lineolaris] &gt;gi|212510859|gb|EEB13950.1| Actin, muscle [Pediculus  
humanus corporis] &gt;gi|326490788|dbj|BAJ90061.1| predicted protein  
[Hordeum vulgare subsp. vulgare]

**Table S3 Summary of reciprocal best matched sequences (RBMs).**

	The number of pairs of RBMs *	CPAG **
Caf ***	31,658	22,976
Cam	42,150	
Cuf	35,692	12,903
Cum	17,929	
Tof	31,560	22,465
Tom	36,318	
Cof	26,169	12,066
Com	17,110	

“\*”: The number of pairs of reciprocal best matched sequences of female or male host sample corresponding to pooled assembly result.

“\*\*”: The number of communal pooled assembly genes, between female RBMs pairs and male RBMs pairs.

“\*\*\*”: Caf and Cam mean cabbage host female and male population, respectively, the same to other host population like cucumber (Cuf and Cum), tomato (Tof and Tom) and cotton (Cof and Com).

**Table S4 Summary of the differentially expressed genes between sexes.**

	Differential expression genes	Female specific*	Male specific**
Caf/Cam	8,434	5,597	2,837
Cuf/Cum	7,817	5,824	1,993
Tof/Tom	6,967	4,304	2,663
Cof/Com	5,151	3,213	1,938

“\*”: Q-value < 0.05 and  $\log_2(\text{Fold change}) > 1$ ; Fold change = normalized reads count in female sample / normalized reads count in male sample.

“\*\*”: Q-value < 0.05 and  $\log_2(\text{Fold change}) < -1$ .

**Table S5 Primers used for the qRT-PCR analyses.**

Num	Gene name	qPCR primer	
		F	R
1	comp324_c0_seq1	CCATCTACCTTGAACGCACTT	GCCATCCGCTACCTGAAA
2	comp7837_c0_seq1	CCCTTCATTCCAGCCTAAATC	GAGTCCACGCAATAGTATTCC
3	comp4718_c0_seq1	TCAGTCGTGCCTTCATTGG	CCTTCTCGCCTACTACAACC
4	comp2284_c0_seq1	TCTGCCTTTCTCAATCCCTCAC	GTAAGCCGTCTCCAACATCAAG
5	comp4969_c0_seq1	GTCTTCAAATCCAGCCAGTAG	ACACATCTCTATGCTTCAACG
6	comp4647_c0_seq1	GTGGCTGCTGTGTAGAAAC	AATCGGTGCTTATCAACGC
7	comp6157_c0_seq1	TCGCTACATCCTTCTTCTG	TTCTCCATCAATTAACCTCTTC
8	comp5682_c0_seq1	GATACATAGGCTGCTAGTTTGG	GGTGACTGGAATCCGATGG
9	comp146_c0_seq1	CTGTGAGGTCGGTGTTAGC	GTGGTCATGTTGGAAGATTCCG
10	comp3174_c0_seq1	TTGGAGGAGCATAGAGGGT	CTAACAGGAGAGTCATCATTTTC
11	comp348_c0_seq4	AGTGTATCGGGCTTTGGAG	CATCTGTGTTGGAGAATCTGG
12	comp6152_c0_seq1	CCGCATATAACGAACGCCATC	CACTGTCCCTCCTAACTCTACG
13	comp2670_c0_seq1	GCCACGACAACCACAAATAGC	CACAGCCTTCAAGCACGATAAG
14	comp1092_c0_seq2	CAGATTGGATTGAAGAACTATG	GGGATGTTGTTGGCTTTAG
15	comp551_c0_seq1	AGGACGGTGGAATAACAG	ATACAAGCGAGGTCACAAATAC
16	comp3004_c0_seq1	ACCAGACTCAATTACTCGCTTC	GTGCCTTGCTCTCAACTCAG
17	comp1458_c0_seq1	ACTTCAACTTGGTTCTCCTC	TGGCTGCTAAGAAGACTTTC
18	comp7178_c0_seq1	CACTTCGGTCAACAACAAC	CTCCACTTCTCCTTTCTCG
19	comp6413_c0_seq2	TGCCAAGAACAGCCACGAC	GCCTCTACCAAAGCGGACTC
20	comp293_c0_seq1	TTGCCAGTTCTTCCATGATACG	ACCTTCGCCCGAGATTTCC
21	comp6113_c0_seq1	TGACAACGCTGACACTGAG	CGTGCTGTATTGCCTTCTAATC
22	comp5525_c0_seq1	ATTGGAATAACTTGCGATGGTG	ACGGTTGCCTTTCTGGATG
23	comp481_c0_seq1	TCACAAAATGGTTCGGAAAG	TGAAATGATACAGTTGATGGG
24	comp247_c0_seq1	AATCCGTTGCCTTGTCATCC	GGTCGTCATCGTGGTATTGG
25	comp4313_c0_seq1	ACAAGACAGCCAACAGAAGG	CCGCATACATCCACATCAAAG
26	comp2936_c0_seq1	AATCACAGTGGAGACCTTCATC	TCTTCTTCTCTGGCAGTTTCG
27	comp1339_c0_seq1	CTGTGCCATCAAGTTCTG	AATATCGGAGTTGTGCTCTTC
28	comp1421_c0_seq1	CTTCAGTAGCCATCGTATCG	ATCCTCCGCATCTTTGTTG
29	comp4282_c0_seq2	TTCACATCCATCTTCTATCAG	TTTCTCTTTCAGCCAATG
30	comp3363_c0_seq1	AGGTCGTGAAGATGTAGATGAG	GGTGGGATGTGAAACTGAAAC
31	comp2860_c0_seq1	TCCGATTAACATCTGATTAGG	CAACCAGTATCTTAGAGTCC
32	comp216_c0_seq1	TGCGAGACAATGACTTACG	CTAACGGAGAAGACCATCAC
33	comp4143_c0_seq1	TGATGAAGTAGTTGAACGAATC	AGTCAGCAGTGGTAACAAG
34	comp2864_c0_seq1	ATGTATGCTGGTCTGGATG	TACTGGTAGAAGGTGTTGAG
35	comp5047_c0_seq1	TCATCTGGTTTCTCTGTTG	AATGGTTCTTCGTCTATGG
36	comp4780_c0_seq1	CTGATGTTATTAGTGGAGTGTC	GGATGATACCTTGTGTTGTTG
37	comp7198_c0_seq1	TCTGCTTCTTGCTGGTTTGG	ACTGGATTGTGGATGATGATGG
38	comp5583_c0_seq1	AGTGATGGTGATGACGATGAC	GACGAAATGCTTCTGTGTATGG
39	comp5474_c0_seq1	CCTTCGGCAAAACAATCTTTAG	TTCAGGAGTCAGGACAACG
40	comp2048_c0_seq1	AGTTGCCAATGAGAGGATACG	GGAGCCAGGTGTGATGAAG
41	comp179_c0_seq1	TAGGGTTCTACTTCTACATTGG	CTGAATTAGCCTGCGTTTAC
42	comp3132_c0_seq1	ACAACATGCCTGCTCCTAC	ATGGTAATGCCTGGTGATAATG

43	comp2416_c0_seq4	GGGAATGCTGAATAAAGTAGAC	CGACGAAATGGAAGAGACC
44	comp2464_c0_seq1	CCAACTGTGAACCGAGAGG	CGAAGAAACCACCCATAAGAG
45	comp11720_c0_seq1	AGTGGTATTCGTAGAGGCATAG	TCGGATGTGATGGCAATGG
46	comp6781_c0_seq1	TGTGATAACGGTCCAAGATG	TATGAGGGCAATCCAGAGG
47	comp3888_c0_seq1	TCTTGGTTCTCTGCTATTTGAC	ATCTTGGCGGATACACTGC
48	comp3885_c0_seq1	TTTGACATTCCGTGCGTTTG	TTGCCACTCCCGATATTGC
49	comp2955_c0_seq1	TCTTTGTGTCTGGACTATCTC	GGTAGTAGGGTGCGTATTG
50	comp1247_c0_seq1	CCATAGTGTTACGCCTAAG	CTTCTTTCCAAGTCTCTCC
51	comp7526_c0_seq3	TGCCGTCAACACAGTAATAG	GACTTGCCATTCAACATCG
52	comp1544_c0_seq1	CCTCTCGTTCGCCTCTAAC	ATACTGTGCTTCGGCTTGG
53	comp9147_c0_seq1	GGATAAGACCGCACGACTATTC	TGAGCCACAGAGGAGATAGC
54	comp2957_c0_seq1	CGCCACGAAGAGCATCATC	CGGTCTTACGAGTACGATTAGC
55	comp6912_c0_seq2	GGTGGTGGTGGTGGCTCTG	GTGGTCGTAGTTGTGGTTGTGG
56	comp1326_c0_seq1	CAACCTGCTTTCAACTTCAC	CTCTCCACATTCCCAATCG
57	comp3063_c1_seq1	TTACCGTGAGCATCCTGAAC	AAACCCAATACCACTCCCAAG
58	comp2170_c0_seq3	GTCCACAGTCTGAGCAATCC	GTTAGTATCCGCCTTCGTATCC
59	comp4572_c0_seq1	GGACTACAGCGTTGAAACC	AACCAGACAAGGAGACACC
60	comp34_c0_seq1	GCTCGTTGTAGAAGGTGTGATG	CCCAGTCCAAGAGAGGTATCC
61	comp3725_c0_seq6	GGAGTACGAGATGACAATACC	CAAGTAATAAGGACCGAAGAGG
62	comp2801_c0_seq1	GAAGTTGACCTGGGCGTAG	TCTGAGAATCCGTGTCTGTG
63	comp634_c2_seq9	CGGACAGGACGGAACAAAC	GACGACGGCGAAGTATTGG
64	comp3102_c0_seq1	GGCGATGTCGTTTCAGGGTAG	GTGTGGGTCAGCGGTGTAG
	RPL29	TCGGAAAATTACCGTGAG	GAACTTGTGATCTACTCCTCTCGTG

**Table S6 qRT-PCR validation and comparative analyses with RNAseq data.**

Number <sup>†</sup>	Gene name	qRT-PCR analyses		Significance <sup>‡</sup>	RNA sequencing					
		Mean $\Delta$ ct (mean $\pm$ se)	Female		The expression ratio 2 <sup>-<math>\Delta\Delta</math>ct</sup>	log2(Fold_change) normalized	TofvsTom	CufvsCum	CafvsCam	CofvsCom
1	comp324_c0_seq1	0.54 $\pm$ 0.13	0.50 $\pm$ 0.22		1.03 >1	2.434175564	2.11066551	1.76937032	1.06757522	1.845446653
2	comp7837_c0_seq1	5.2 $\pm$ 0.03	5.7 $\pm$ 0.07	**	0.71	1.884507783	4.649603558	2.65321818	4.56012342	3.436863235
3	comp4718_c0_seq1	6.9 $\pm$ 0.03	6.2 $\pm$ 0.1	**	1.62 > 1	4.110145092	4.662396584	3.63771135	4.49533044	4.23 > 2
4	comp2284_c0_seq1	5.2 $\pm$ 0.02	4.6 $\pm$ 0.09	**	1.52 > 1	1.905370666	2.026732393	1.34643919	1.74091719	1.754864859
5	comp4969_c0_seq1	5.6 $\pm$ 0.06	6.0 $\pm$ 0.1	*	0.76	1.484874081	3.725267827	1.70704817	5.7235477	3.16 > 2
6	comp4647_c0_seq1	5.8 $\pm$ 0.02	6.4 $\pm$ 0.1	**	0.66	1.092299629	3.466340257	1.10991284	3.38060518	2.26 > 2
7	comp6157_c0_seq1	6.7 $\pm$ 0.16	6.0 $\pm$ 0.08	*	1.62 > 1	2.28674517	7.52180926	2.50703971	3.11537516	3.86 > 2
8	comp5682_c0_seq1	4.7 $\pm$ 0.15	4.8 $\pm$ 0.1		0.93	1.827643684	2.039049343	1.71725161	2.87368804	2.11 > 2
9	comp146_c0_seq1	0.21 $\pm$ 0.03	(-0.025) $\pm$ 0.11		1.18 > 1	2.539082832	2.173598267	1.99778794	1.12916724	1.959909069
10	comp3174_c0_seq1	2.7 $\pm$ 0.14	3.7 $\pm$ 0.06	**	0.4973333	1.727603953	2.749147686	1.95168696	1.64006837	2.02 > 2
11	comp348_c0_seq4	0.86 $\pm$ 0.06	0.79 $\pm$ 0.09		1.05 > 1	2.162156838	3.07692534	1.89976491	1.12833922	2.07 > 2
12	comp6152_c0_seq1	6.7 $\pm$ 0.04	6.3 $\pm$ 0.18		1.32 > 1	2.068661908	4.064844499	3.36327707	4.48695165	3.50 >2
13	comp2670_c0_seq1	3.7 $\pm$ 0.18	3.8 $\pm$ 0.2		0.9323333	1.723653108	3.626668444	1.97814485	1.23858091	2.14 > 2
14	comp1092_c0_seq2	3.0 $\pm$ 0.07	1.5 $\pm$ 0.11	***	2.83 > 1	2.448858975	2.998227813	2.156869	1.43617853	2.26 > 2
15	comp551_c0_seq1	2.4 $\pm$ 0.14	2.1 $\pm$ 0.13		1.23 > 1	2.300617036	4.124596936	2.20448327	2.25984483	2.72 > 2
16	comp3004_c0_seq1	6.1 $\pm$ 0.10	6.0 $\pm$ 0.14		1.07 > 1	1.603506088	1.66871238	1.72597186	2.42887599	1.85676658
17	comp1458_c0_seq1	0.83 $\pm$ 0.04	0.36 $\pm$ 0.2	***	1.39 > 1	1.183736829	4.345223664	1.70126759	1.38262817	2.15 > 2
18	comp7178_c0_seq1	2.0 $\pm$ 0.13	4.6 $\pm$ 0.03	***	0.16	2.152260737	3.486974619	1.36912631	5.07076688	3.02 > 2
19	comp6413_c0_seq2	6.8 $\pm$ 0.09	6.5 $\pm$ 0.1		1.23 > 1	1.763500579	5.587585272	2.5142291	3.12241799	3.25 > 2
20	comp293_c0_seq1	0.86 $\pm$ 0.04	0.73 $\pm$ 0.03		1.09 > 1	2.163277898	2.791766088	1.89228481	1.03505498	1.970595944
21	comp6113_c0_seq1	4.4 $\pm$ 0.13	4.5 $\pm$ 0.03		0.9273333	1.745751984	4.61890676	3.60882575	2.89640812	3.22 > 2
22	comp5525_c0_seq1	3.4 $\pm$ 0.10	4.7 $\pm$ 0.07	***	0.41	2.235408786	8.301428013	2.53649272	2.97098525	4.01 > 2
23	comp481_c0_seq1	1.1 $\pm$ 0.05	0.38 $\pm$ 0.03	***	1.65 > 1	2.224663907	3.487300484	2.03239627	1.10853312	2.21 > 2
24	comp247_c0_seq1	0.27 $\pm$ 0.08	(-0.52) $\pm$ 0.04	***	1.73 > 1	2.291326738	3.104952879	1.96606158	1.10122783	2.12 > 2
25	comp4313_c0_seq1	6.5 $\pm$ 0.02	5.2 $\pm$ 0.00	***	2.46 > 1	3.685344493	5.981852458	3.57431979	5.44331889	4.67 > 2
26	comp2936_c0_seq1	5.6 $\pm$ 0.12	4.8 $\pm$ 0.05	**	1.74 > 1	2.105837969	3.923517935	3.35223981	3.55458164	3.23 > 2



27	comp1339_c0_seq1	4.1±0.0	2.7±0.03	***	2.64 > 1	2.663641106	3.232097803	3.45390368	2.32051782	2.92 > 2
28	comp1421_c0_seq1	4.5±0.14	4.4±0.13		1.07 > 1	3.058171011	2.540014039	4.17323746	2.14672537	2.98 > 2
29	comp4282_c0_seq2	4.3±0.08	4.2±0.23		1.07 > 1	1.317777909	6.926031505	2.39992718	2.06947511	3.18 > 2
30	comp3363_c0_seq1	3.6±0.09	4.0±0.02	*	0.7573333	1.469916901	2.189646403	1.5298989	2.53695451	1.931604179
31	comp2860_c0_seq1	3.1±0.16	3.7±0.08	*	0.66	1.206966093	4.187950699	1.91561384	1.54689839	2.21 > 2
32	comp216_c0_seq1	1.3±0.02	0.71±0.04	***	1.51 > 1	2.631716362	2.018396754	2.02037846	1.24519539	1.978921741
33	comp4143_c0_seq1	4.9±0.11	4.9±0.16		1.00 > 1	2.626778727	2.369167592	2.24252003	2.14576759	2.35 > 2
34	comp2864_c0_seq1	4.5±0.06	4.5±0.3		1.00 > 1	1.750348158	2.967625375	2.05059631	1.49454676	2.07 > 2
35	comp5047_c0_seq1	6.5±0.24	6.2±0.18		1.23 > 1	2.520964061	6.24362285	4.70236005	3.45683647	4.23 > 2
36	comp4780_c0_seq1	4.9±0.16	4.1±0.05	*	1.74 > 1	5.316148489	7.581432055	4.75949827	6.18922732	5.96 > 2
37	comp7198_c0_seq1	6.0±0.09	6.1±0.03		0.93	4.289305608	5.73445282	3.81793009	3.86619529	4.43 > 2
38	comp5583_c0_seq1	6.5±0.17	5.7±0.1	*	1.74 > 1	2.362931449	8.92186798	4.82894224	5.33159381	5.36 > 2
39	comp5474_c0_seq1	4.9±0.07	5.0±0.05		0.93	1.850255366	4.776982864	2.15793806	3.51351248	3.07 > 2
40	comp2048_c0_seq1	7.1±0.10	5.7±0.02	***	2.64 > 1	3.131345373	5.510866335	4.12546948	2.84294236	3.90 > 2
41	comp179_c0_seq1	1.4±0.03	0.52±0.03	***	1.84 > 1	1.631547209	5.210097714	1.88404314	2.70344938	2.86 > 2
42	comp3132_c0_seq1	1.4±0.18	1.1±0.03		1.23 > 1	1.910577509	7.990373961	1.67102784	1.61485444	3.30 > 2
43	comp2416_c0_seq4	3.5±0.12	3.8±0.05		0.81	1.238623438	3.021705111	1.40602694	1.29674179	1.74077432
44	comp2464_c0_seq1	2.9±0.11	3.6±0.05	**	0.62	1.01362746	2.830519343	1.35351647	1.0859038	1.570891769
45	comp11720_c0_seq1	8.2±0.04	7.7±0.12	***	1.41 > 1	6.554687029	4.206174458	3.89885075	4.15996451	4.70 > 2
46	comp6781_c0_seq1	7.3±0.15	7.5±0.00		0.87	1.618489518	3.275208043	2.07704967	6.23532585	3.30 > 2
47	comp3888_c0_seq1	6.9±0.18	5.4±0.00	**	2.83 > 1	2.244216271	3.805153537	4.10511613	2.82668456	3.25 > 2
48	comp3885_c0_seq1	8.3±0.2	6.1±0.06	***	4.59 > 1	3.025382723	6.850416924	3.57468795	4.95921547	4.60 > 2
Male/Female										
49	comp2955_c0_seq1	2.2±0.03	6.4±0.14	***	18.4 > 1	-2.493729422	-3.16174065	-2.89677336	-1.8834825	(-2.61) < -2
50	comp1247_c0_seq1	(-1.4)±0.05	1.4±0.04	***	6.96 > 1	-2.026726664	-1.11056694	-4.66348629	-1.7798178	(-2.40) < -2
51	comp7526_c0_seq3	2.6±0.16	5.0±0.08	***	5.28 > 1	-1.278159541	-1.82997121	-3.6368774	-2.4345209	(-2.29) < -2
52	comp1544_c0_seq1	2.8±0.19	4.4±0.09	**	3.03 > 1	-2.901270922	-1.72130228	-4.65960214	-2.0629037	(-2.84) < -2
53	comp9147_c0_seq1	3.1±0.05	5.4±0.00	***	4.92 > 1	-1.945714422	-1.760486	-2.15488543	-2.3329349	(-2.05) < -2
54	comp2957_c0_seq1	3.4±0.12	5.6±0.1	***	4.59 > 1	-1.858174587	-1.99930586	-1.3728331	-1.9855221	-1.8
55	comp6912_c0_seq2	2.7±0.15	6.9±0.05	***	18.4 > 1	-3.384931938	-2.21276837	-2.3793914	-1.690391	(-2.42) < -2
56	comp1326_c0_seq1	1.8±0.05	4.7±0.1	***	7.46 > 1	-2.327329687	-1.83912669	-2.31347968	-2.3416269	(-2.21) < -2
57	comp3063_c1_seq1	0.7±0.1	4.2±0.1	***	11.3 > 1	-3.033413149	-2.61137519	-2.9367121	-2.4169628	(-2.75) < -2

58	comp2170_c0_seq3	7.7±0.1	7.5±0.1		0.871	-2.380423026	-2.05599787	-3.03948815	-2.4066335	(-2.47) < -2
59	comp4572_c0_seq1	3.8±0.09	5.9±0.19	***	4.29 > 1	-2.398537969	-3.26974059	-6.44088776	-2.0725053	(-3.55) < -2
60	comp34_c0_seq1	(-3.4)±0.14	(-0.80)±0.07	***	6.06 > 1	-1.389336008	-3.34592023	-2.56927462	-1.6409565	(-2.24) < -2
61	comp3725_c0_seq6	1.4±0.06	4.5±0.00	***	8.57 > 1	-2.472388813	-1.42730154	-1.61923938	-1.700457	-1.8
62	comp2801_c0_seq1	3.0±0.1	5.8±0.05	***	6.96 > 1	-1.847586943	-1.16631338	-2.48064497	-2.2754671	-1.94
63	comp634_c2_seq9	5.1±0.15	8.0±0.2	***	7.46 > 1	-3.657515211	-2.40929013	-2.7401361	-3.6422711	(-3.11) < -2
64	comp3102_c0_seq1	1.0±0.2	4.6±0.24	***	12.1 > 1	-1.787179932	-2.30957043	-7.51866243	-2.9313057	(-3.64) < -2

"\$": Number 1-48 is from female enriched genes and number 49-64 is from male enriched genes.

"#": \* means P<0.05; \*\* means P<0.01; \*\*\* means P<0.001.